

QC-S3G SERIES OPERATION MANUAL

DRIVE AND CONTROL INTEGRATED THREE-AXIS
MANIPULATOR CONTROL SYSTEM V4.1



深圳市华成工业控制股份有限公司

Shenzhen Huacheng Industrial Control Co., Ltd.

Introduction

First of all, thank you very much for choosing QC-S3G series drive and control integrated three axis control system from Shenzhen Huacheng Industrial Control Co.,Ltd.

This user's manual is QC-S3G series drive and control three axis control system, which will provide you with the installation, wiring, system operation, alarm and other related details and precautions.

In order to correctly use the QC-S3G series drive and control integrated three axis control system, give full performance of the system and ensure the safety of users and equipment, please read this user manual in detail before using this system. Improper operation and use may cause QC-S3G series of drive and control integrated three axis control system abnormal operation and even equipment damage, personal injury and other accidents!

Due to our commitment of continuous improvement of products, there will be no further notice if the material provided by the company is changed.

CONTENTS

INTRODUCTION.....	I
CHAPTER 1 SYSTEM MODEL SELECTION.....	1
1.1 System Model Description.....	1
CHAPTER 2 SYSTEM CONFIGURATION AND INSTALLATION.....	2
2.1 System Basic Configuration.....	2
2.2 Safety Reminder and System Installation.....	2
2.2.1 Precautions for Preservation and Removals.....	2
2.2.2 Matters Needing Attention.....	2
2.2.3 Prohibited Operations.....	2
2.2.4 Precautions in Abandonment.....	2
2.2.5 System Installation.....	3
2.2.6 Safety Precautions.....	3
2.3 Installation and External Wiring Requirements.....	5
2.3.1 Installation Direction and Space Requirements.....	5
2.3.2 Cable Requirements and Wiring.....	5
CHAPTER 3 SYSTEM INSTALLATION AND WIRING INSTRUCTIONS.....	9
3.1 System Wiring Diagram.....	9
3.1.1 Machine Wiring.....	9
3.1.2 Dimensional Drawing.....	10
3.2 Power Input Definitions.....	15
3.3 I/O Port Wiring Diagram.....	15
3.4 Servo Motor Connection Definition.....	17
3.4.1 Power Line Definition.....	17
3.4.2 Encoder Line Definition.....	18
3.4.3 Wiring Diagram of Motor Band Brake.....	19
3.5 Connection of Manipulator to Injection Molding Machine.....	19
CHAPTER 4 COMMISSIONING AND OPERATION MODE.....	20
4.1 Appearance and Description.....	20
4.2 Main Screen.....	20
4.3 Operation Mode.....	20
4.3.1 Pre-run Inspections.....	20
4.3.2 Test Run of Servo Axis.....	21
4.3.3 Origin Point Reset.....	22
4.3.4 Manual Operation.....	24
4.3.5 Teaching Page.....	25
4.3.6 Automatic Status.....	26
4.4 Example of Test Run:.....	27
CHAPTER 5 FUNCTION SETTING.....	28
5.1 Basic Function.....	28
5.1.1 Function Keys.....	28
5.1.2 Fine Tuning Knob.....	29
5.2 Main Screen and Axis Definition.....	29
5.3 State Knob.....	30
CHAPTER 6 MANUAL STATUS.....	31
6.1 Operation of Manual Pages.....	31
6.1.1 Fixture Page.....	31
6.1.2 Manual Operation of Auxiliary Equipment.....	31
6.1.3 Manual Operation of Reserve Action.....	32

6.2 Teaching Page.....	32
6.2.1 Teaching of Axis Movement.....	34
6.2.2 Teaching of Program Starting Point.....	35
6.2.3 Stack Instruction.....	36
6.2.4 Teaching of Fixture and Detection Program.....	37
6.2.5 Teaching of IMM Signal.....	38
6.2.6 Teaching of Auxiliary Equipment.....	39
6.2.7 Reserve Instruction.....	39
6.2.8 Wait.....	40
6.2.9 Manipulator I/O.....	41
6.2.10 Sequence Action.....	41
6.2.11 Program Quick Setting.....	42
6.2.12 Comment.....	43
6.2.13 Condition Teaching.....	44
6.2.14 Teaching of Insert Program.....	48
6.2.15 Modification of Program Parameters.....	49
6.3 Examples of Teaching Program.....	50
6.3.1 Requirement.....	50
6.3.2 Procedures.....	50
6.3.3 Programming.....	51
CHAPTER 7 STOP STATE.....	52
7.1 Program Management.....	52
7.2 Function.....	53
7.2.1 Signal Settings.....	53
7.2.2 Product Settings.....	55
7.2.3 Machine Configure.....	56
7.2.4 The Relationship between Several Speeds.....	56
7.2.5 Structure Settings and Security Point Settings.....	57
7.2.6 Servo Parameters.....	64
7.2.7 Servo Parameter Table.....	65
7.2.8 Machine Time.....	67
7.2.9 Stack Settings.....	67
7.2.10 System Settings.....	70
7.2.11 Maintenance.....	72
CHAPTER 8 AUTOMATIC STATUS.....	74
8.1 Monitoring of Auto-running Data.....	74
8.2 Modification of Parameters in Automatic Operation.....	74
8.3 Single Step Operation.....	75
8.4 Single Cycle.....	75
8.5 Speed Adjustment during Automatic Operation.....	75
CHAPTER 9 MONITOR AND ALARM RECORD.....	76
9.1 I/O Monitor.....	76
9.2 Alarm History.....	76
9.3 Modify Log.....	77
9.4 Alarms and Solutions.....	78
APPENDIX MODBUS FUNCTION ADDRESS AND PARAMETER DEFINITIONS.....	125

Chapter 1 Introduction to System Model

1.1 System Model Description

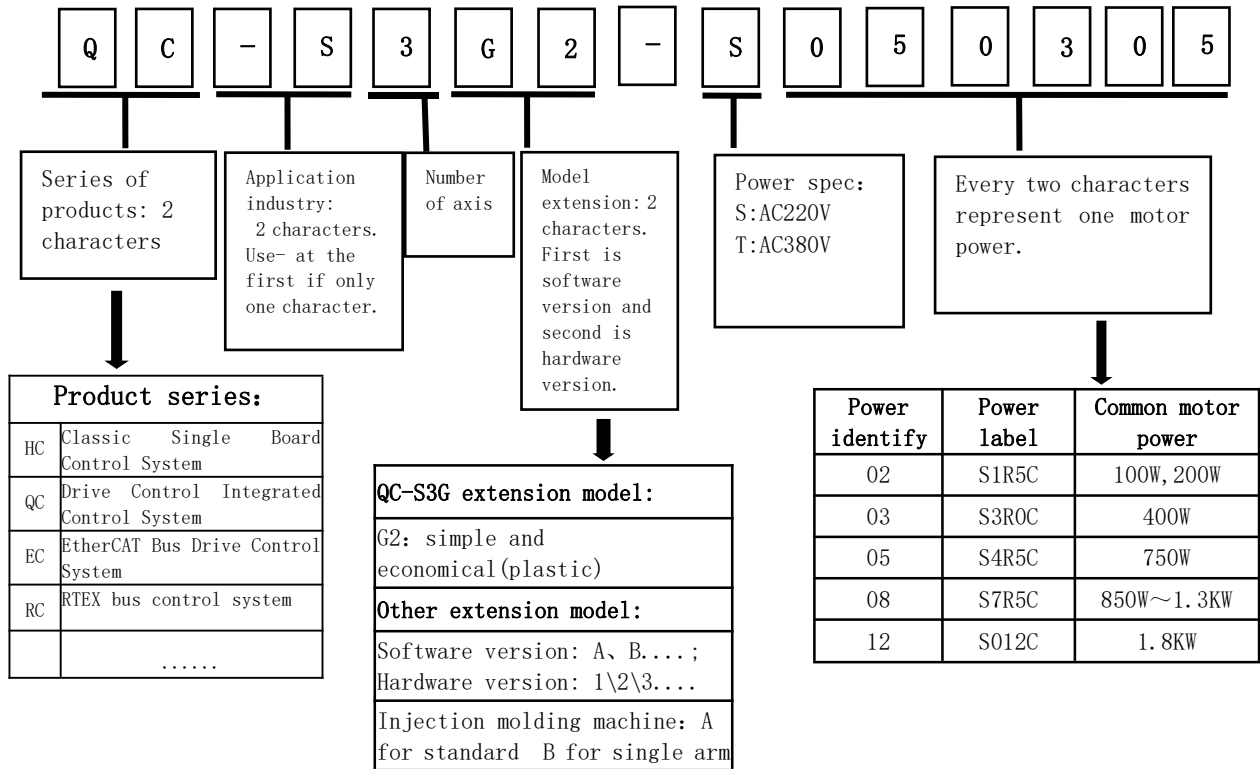

For example:

QC-S3G2-S050305: The manipulator control system of three-axis drive-control integrated injection machine with economical plastic shell;

Z axis servo: 750W/AC220V; X axis servo: 400W/AC220V;

Y axis servo: 750W/AC220V; The upper cover corresponds to the servo power label.

***Note: This product does not support AC380V current input**

Chapter 2 System Configuration and Installation

2.1 System Basic Configuration

- 1) 8-inch color display operation panel (optional transfer cable length, 1m standard);
- 2) Drive-control integrated control box;
- 3) Servo motor (400W/750W) ;
- 4) Brake resistance;
- 5) Power supply unit (optional part) ;
- 6) UVW power line and encoder line (optional part, length is optional);

2.2 Safety Reminder and System Installation

The safety content of this manual is as following. The description of the safety mark is very important. Please abide by it.



Attention! The risk of not operating as required may lead to moderate or minor injury, and equipment damage.

2.2.1 Precautions for Preservation and Removals

***Note:** Do not store, place machine in the following environment, otherwise it will cause fire, electric shock or machine damage.

- 1) Places with direct sunlight, where the temperature or relative humidity exceeds the required level, and places where the temperature difference is large and dewy.
- 2) Places close to corrosive gases, flammable gases, or with great quantity of dust, salt and metal dust; Places with water, oil and medicine drip, or where vibration or shock can be transmitted to the main part. Do not hold the cable during removals, otherwise it will cause machine damage or malfunction.

2.2.2 Matters Needing Attention

- 1) Do not stack too many products, otherwise it will cause damage or malfunction.
- 2) This product is a general industrial product. Don't use to hurt people's life and health.
- 3) Please configure the safety device if applied to devices that may cause major accidents or damage due to the malfunction of this product.
- 4) If used in an environment of sulphur or high concentrations of sulfuric gas, please note that due to vulcanization, chip resistance may be broken or poor contacted.
- 5) If the input voltage far exceeds the rated range of the power supply of this product, smoke and fire may occur due to the damage of internal components, please pay full attention to the input voltage.
- 6) Please note that this product can not guarantee the use beyond the product specification.
- 7) The company is committed to the continuous improvement of products and may change some parts.

2.2.3 Prohibited Operations

Except with our professional personnel, do not dismantle or carry out maintenance.

2.2.4 Precautions in Abandonment



Attention!



When the product needs to be treated as waste after normal use, please abide by the relevant department's legal regulations on the recovery and reuse of electronic information products.

2.2.5 System Installation

- 1) Wiring work must be carried out by a professional electrician.
- 2) Make sure that the power supply is disconnected before starting work.
- 3) Please install on metal and other flame retardants and away from combustible.
- 4) Be sure that the machine is well grounded while using.
- 5) If the external power supply is abnormal, the control system will fail. Please set a safety circuit outside the control system to make the control system work safely.
- 6) Please be familiar with the contents of this manual before installation, wiring, operation and maintenance. Please be familiar with related machinery and electronics knowledge and all relevant safety precautions while using.
- 7) The electric box where the controller is installed should be well ventilated, oilproof and dustproof. If box is airtight, it needs to install ventilation fan to prevent the controller from abnormal work caused by high temperature. The appropriate temperature is under 50°C. Do not use in frozen or dewy places.
- 8) Avoid to place the controller too close to contactor, frequency converter and other AC devices while installing, in case of unnecessary surge interference.

2.2.6 Safety Precautions

 Attention!	<p>Encoder must use shielded cable and shielding layer must be single-end well grounded!</p> <p>Do not install frequency converter or other devices that generate electromagnetic waves or interference near the servo driver, otherwise the servo driver will have the wrong action. If there is a need, set an anti-jamming shield between it and the servo driver.</p>
	<p>Please follow the steps specified in the electrostatic precautions (ESD) when operating the servo driver, otherwise the internal circuit of the servo driver will be damaged by static electricity.</p> <p>Please follow the local standard for branch and short circuit protection. If the protection measures are improper, it may cause servo driver damage.</p> <p>Do not share ground wires with welding machines or power machines requiring high current, otherwise the servo driver or machine will not work well.</p> <p>When using several servo drivers, please follow the contents of this manual. Do not wrap the ground wire into a circle, otherwise it will cause abnormal operation of servo driver or machine.</p> <p>Do not connect or operate if there are parts lost or obviously damaged. Wiring, inspection and other operations should be done by the professional.</p>
	<p>Rotating motor would feed power to servo drivers so that the servo driver is still live even after the motor is cut off and stops. Make sure the motor servo driver is safely disconnected before maintenance.</p>

 Attention!	<p>Do not do wiring with power on, otherwise there will be a risk of electric shock. Please cut off the power of all equipment before checking. Even if the power supply is cut off, there is residual voltage in the internal capacitor. After cutting off the power, please wait at least 10 minutes.</p> <p>Contact current of servo driver is more than 3.5 mA. Please make sure servo driver is well grounded, otherwise there will be a risk of electric shock.</p>
	Power on
	<p>Do not open the cover plate after power on, otherwise there will be a risk of electric shock!</p> <p>Do not touch any input and output terminals of the servo driver, otherwise there will be a risk of electric shock!</p> <p>Do not remove the cover plate of the servo driver or touch the printed circuit board with power on, otherwise there will be a risk of electric shock.</p> <p>Do not arbitrarily change the manufacturer parameters of servo driver, otherwise it may cause damage to the equipment!</p>
	In service
	<p>Do not detect signals in operation if not professional, otherwise it may cause personal injury or equipment damage!</p> <p>Do not touch the cooling fan and discharge resistance to test the temperature, otherwise it may cause burns!</p> <p>Avoid there is anything falling into the equipment in operation, otherwise it may cause equipment damage!</p>
	Maintenance
 Attention!	<p>Do not repair or maintain servo drivers without professional training, otherwise it may cause personal injury or equipment damage!</p> <p>Do not repair or maintain with power on, otherwise there will be a risk of electric shock! Confirm that the input power of the servo driver is cut off and wait for 10 minutes before repairing or maintenance, otherwise the residual charge on the capacitor will do harm to people!</p> <p>Make sure the servo driver is safely disconnected from all power sources before performing maintenance work.</p> <p>All pluggable units must be plugged with power off!</p> <p>The parameters must be set and checked after changing the servo driver.</p> <p>Do not power up the damaged machine, otherwise it will expand the damage.</p>
	<p>Ensure that the phase sequence of the motor terminal is consistent with the servo driver terminal. If not, the motor will rotate in reverse.</p> <p>Do not connect the power with the output terminal of the servo driver, otherwise it will cause damage to the servo driver and even fire.</p> <p>Some systems may act suddenly when electrified, with a risk of death or serious injury.</p> <p>Before turning on the servo driver, make sure the cover is firmly installed and the motor is allowed to restart.</p> <p>Before turning on the servo driver, please confirm that the rated voltage is consistent with the power supply. If the main circuit power supply voltage is used incorrectly, it may cause fire.</p> <p>Do not connect the input power with the output terminal (U、V、W) of the servo driver, otherwise the servo driver will be damaged!</p> <p>Do not carry out installation, maintenance, inspection or replacement of components if not professional electrical construction crew, otherwise there will be a risk of electric shock.</p>

Note: Improper handling may cause risks, including personal injury or equipment accidents.

2.3 Installation and External Wring Requirements

2.3.1 Installation Direction and Space Requirements

Installation direction: the normal installation direction of the servo driver is vertical and upright. Servo driver, chassis space and intervals between other equipment must be ≥ 10 CM. Please refer to the figure below and note that the diagram indicates the minimum size. Please keep adequate installation intervals to ensure the performance and life of the driver.

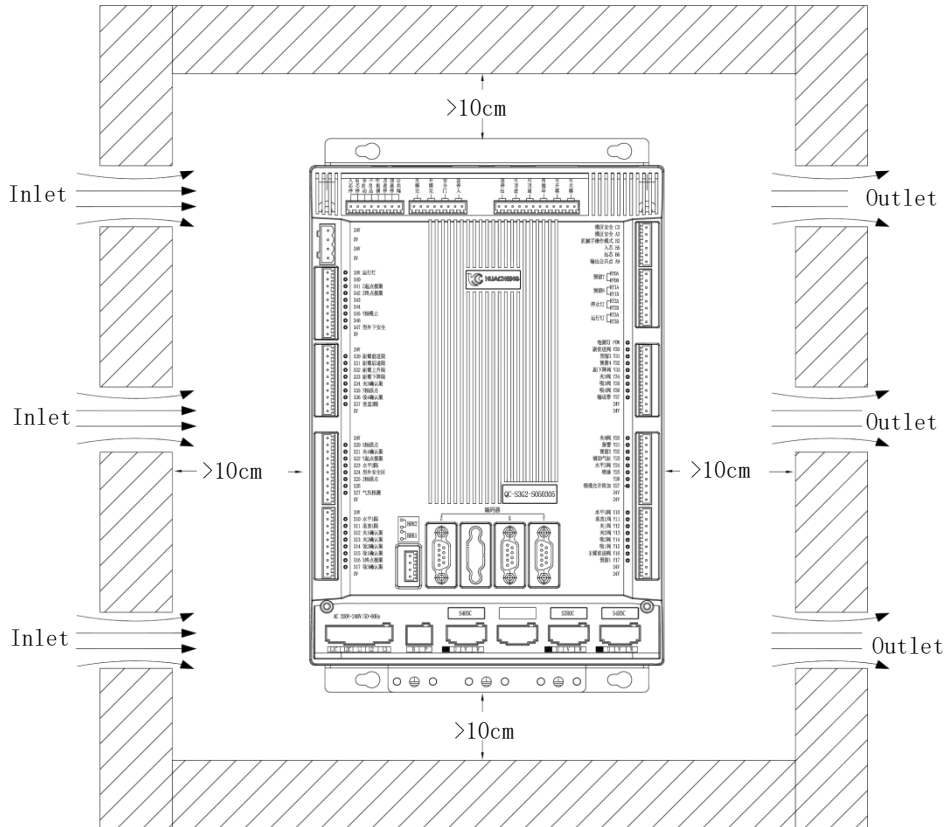

Heat elimination:

The servo driver uses the fan to abstract heat. It is best to install a ventilation slot or a heat dissipation fan in the electrical control cabinet to ensure that the drive-control integrated machine in the chassis is in a place where is cool and airy.

2.3.2 Cable Requirements and Wiring

2.3.2.1 Shielding Cables

To meet the requirements of EMC, it must use shielded cables with shielding layer for encoder line. It's recommended to use shielded cables with shielding layer for power line or install a magnetic ring(suggested spec is R3H 22×28×7.0). Shielded cable is shown as P1. Power line with magnetic ring is shown as P2. As we suggest, installing magnetic ring is more recommended.

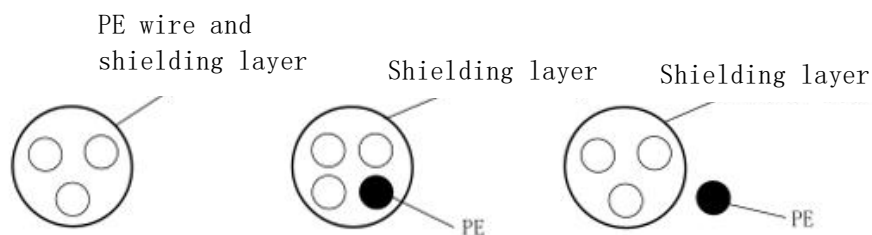

P1 Shielded Cable Requirements(for encoder line)

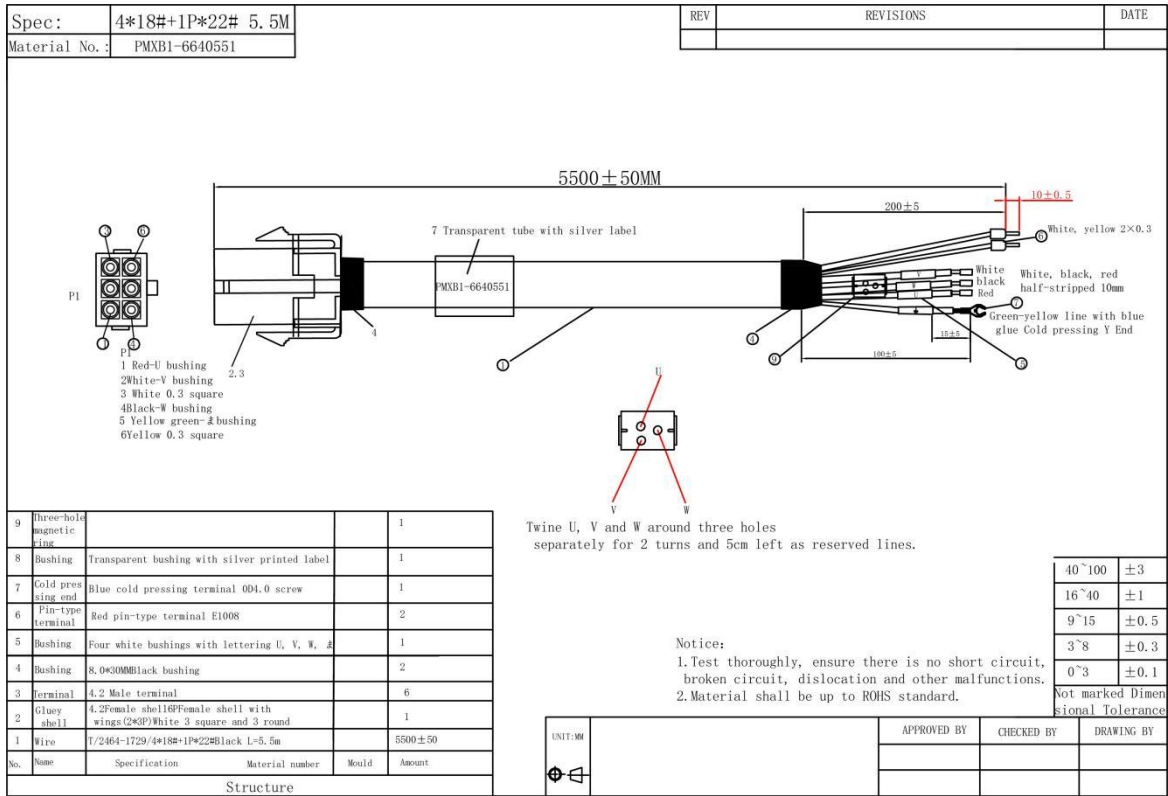

P2 Power line with magnetic ring

In order to suppress RF interference emission and conduction effectively, the shielding layer of the shielded cable is composed of coaxial copper braided wire. To increase the shielding efficiency and conductivity, the braid density of the shield layer should be greater than 90% as the following picture.

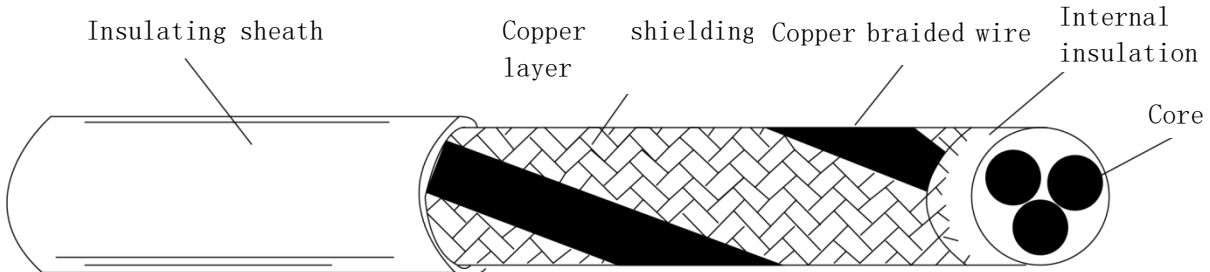

Woven density of shielding layer

Installation considerations:

- Shielded symmetrical cables are recommended for all shielded cables, and four-core cables can also be used as input cables ;
- Cables and PE shielded conductor (stranded shield) should be as short as possible to decrease EMR, stray current and capacitive current outside;
- It is recommended to use shielded cable as control cables;
- It is recommended to use shielded cables or steel pipe shielded power lines as output power line of driver with the shielding layer well grounded. Cables for equipment under interference shall use shielded twisted-pair with the shielding layer well grounded.

2.3.2.2 Cable Wiring Requirements

- 1) Motor cables should be far away from others; Motor cables of drivers can be wired paralleled.

- 2) It is recommended to place motor cables, input power cables and control cables in different chutes. Long-distance parallel wiring should be forbidden to avoid EMR caused by fast change of driver's output voltage.
- 3) Try to keep perpendicular if the control cable has to cross power cable. Do not let other cables cross the driver.
- 4) Try not to wire input power line, output power line of driver and weak signal lines such as control lines paralleled, perpendicular if possible.
- 5) Chutes must be well connected and grounded. Aluminium chutes can improve equipotential.
- 6) Filter, driver and motor should be well connected with system (machine or equipment). The installed part should be painted and make conductive metal fully contacted.
- 7) Wiring diagram is shown as bellow:

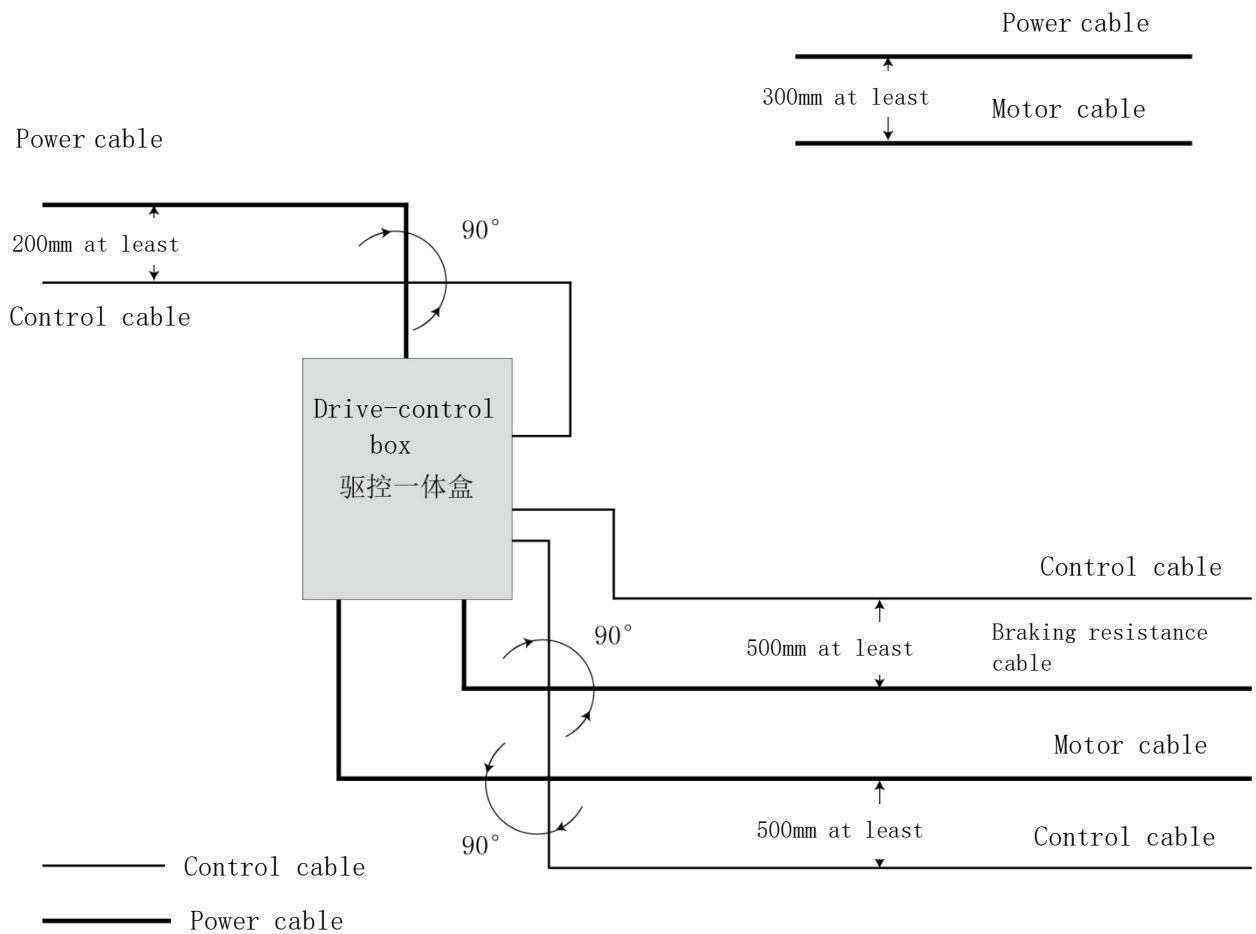

2.3.2.3 Common EMC problems and solutions

Driver products can cause strong interference. It may happen if there are problems in wiring or grounding. Solutions in this chart can be used.

Common EMC Interference Problems and Solutions

Interference type	Solutions
Trip of current leakage protection circuit breaker	Lower the carrier frequency; Shorten the drive line; Add wound magnetic ring to the input drive line(not PE line); Disconnect the larger capacitance in input port if trip happens the moment power on;(disconnect the ground terminals of internal or external filter and earth Y capacity in input port) For running or enable trip, it needs to take current leakage restraining measures (current leakage filter, safety guage capacitor + wound magnetic ring);
Interference caused by driver running	Connect motor' s shell with PE terminal of driver; Connect PE terminal of driver with PE of electric net; Add wound magnetic ring to the input power line; Add capacitance or wound magnetic ring to interfered signal port; Additional common-ground connection between devices;
Communication interference	Connect motor' s shell with PE terminal of driver; Connect PE terminal of driver with PE of electric net; Add wound magnetic ring to the input power line; Add matching resistance to communication line source and load terminal; Connect differential line of communication line with communication common-ground wire outside; Use shielded lines as communication lines and connect the shielding layer with communication common-ground wire; Use daisy chain in multi-point communication wiring and the length of branches should be less than 30cm;

Chapter 3 System Installation and Wiring Instructions

3.1 System Wiring Diagram

3.1.1 Machine Wiring

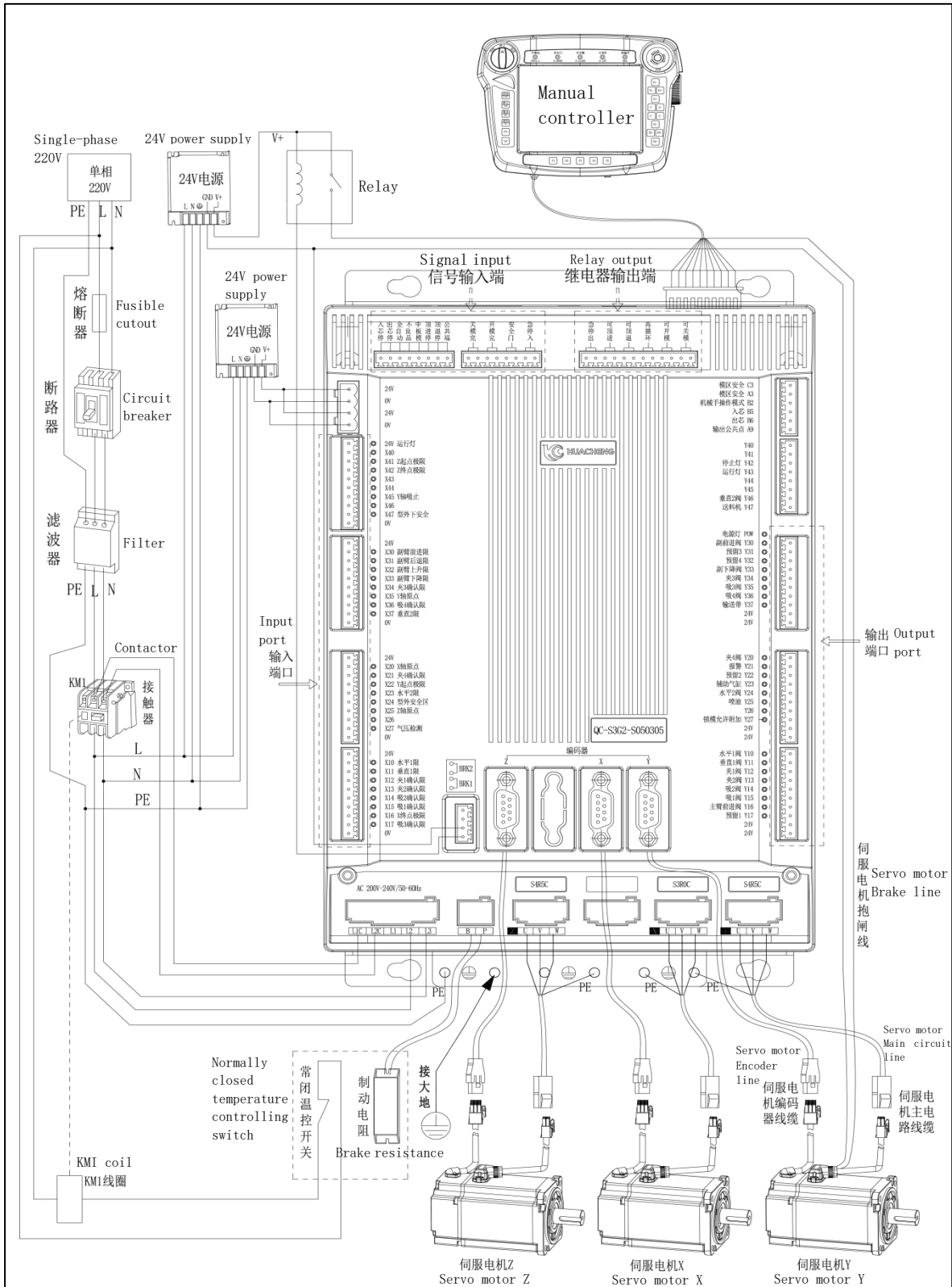

Notice:Users need to evaluate whether the IO power supply exceeds the standard 50W, if it exceeds, they need to replace the high-power power supply.

3.1.2 Dimensional Drawing

3.1.2.1 Main control dimensions

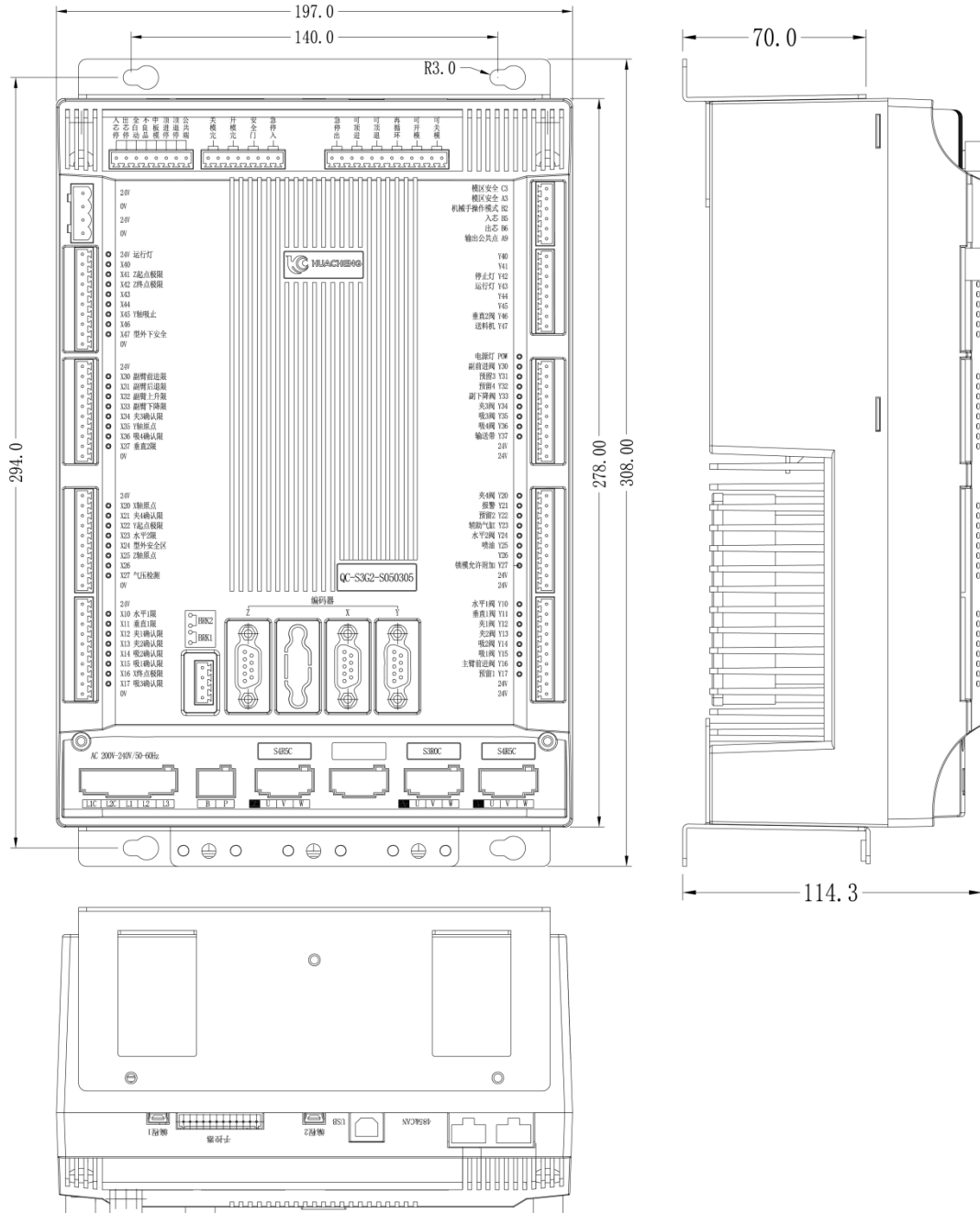

Installation	Screw Spec	Length (max)	Torque (max)
Fixed by screw	M5	8mm	7.5kgf.cm

3.1.2.2 Single switch power supply installation dimensions and wiring

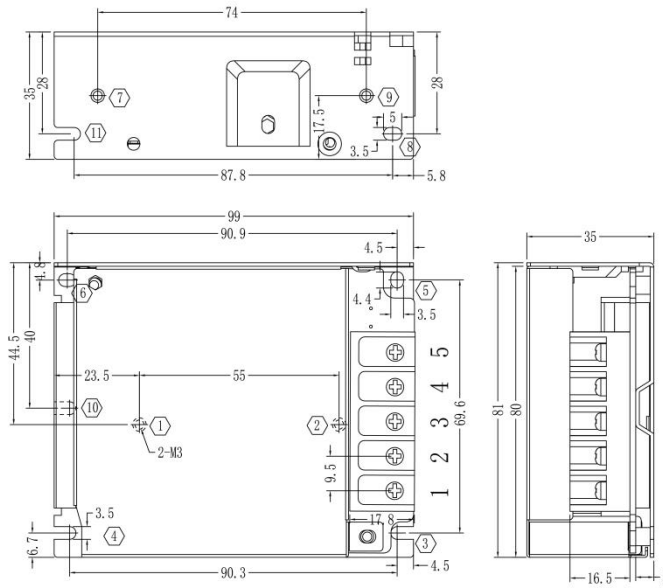

Installation	Installation Number	Screw Spec	Length(max)	Torque (max)
Fixed by screw	①--②	M3	5mm	6.5kgf. cm
	⑦--⑨			
	③--⑥	M3	3mm	7kgf. cm
	⑩--⑫			

3.1.2.3 Brake resistance dimensions

Installation	Screw spec	Length (max)	Torque (max)
Fixed by screw	M5	8mm	7.5kgf. cm

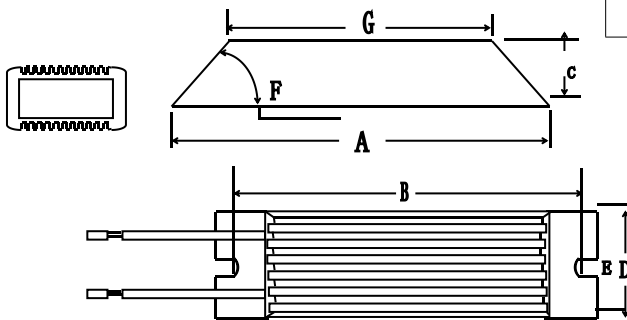

Model	25°C-40°C power rating (W)	Dimensions (mm)							Range of resistance
		Resistor							
		A±1.0	B±1.0	C±1.0	D±1.0	E±0.5	F	G±1.0	
RXLG	200	165	147	30	60	5.6	45°	119	0.1~20K

3.1.2.4 Motor parameters and shape dimensions

400W motor parameters and dimensions:

400W motor parameters										
Model \ Spec	LL	LC	LR	LA	LZ	LH	LG	LE	LJ	
400W with Brakes	<180	60	30	70	4- φ5.5	≤50	NA	3±0.5	1±0.35	
400W No brakes	<130	60	30	70	4- φ5.5	≤50	NA	3±0.5	1±0.35	
Model \ Spec	S	LB	TP	LK	KH	KW	W	T	Weight (kg)	
400W with Brakes	14	50	M5*10	≤23	11	5	5	5	NA	
400W No brakes	14	50	M5*10	≤23	11	5	5	5	NA	

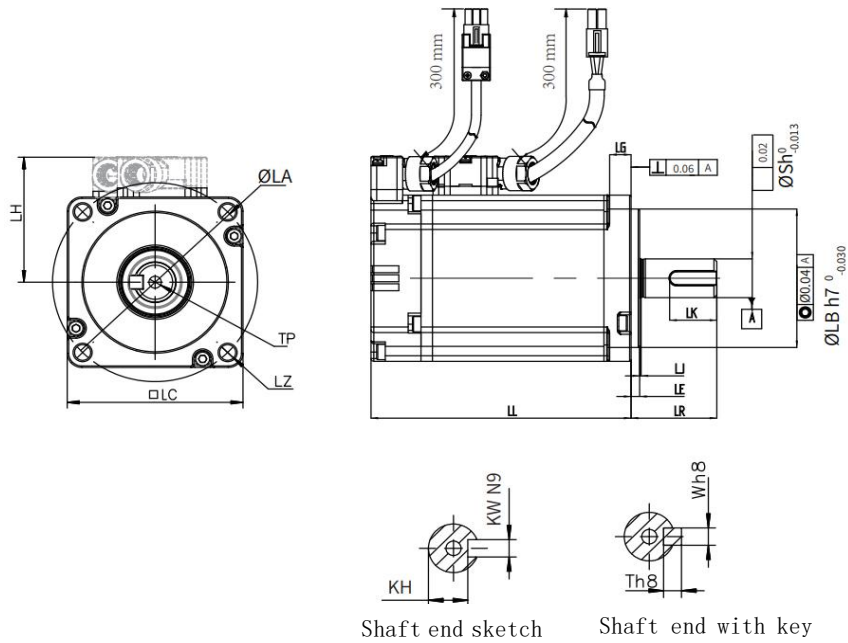

(400W Motor Dimensional Drawing)

750W motor parameters and dimensions:

750W motor parameters										
Model \ Spec	LL	LC	LR	LA	LZ	LH	LG	LE	LJ	
750W Brakes	<190	80	35	90	4- φ7	≤55	NA	3±0.5	1±0.35	
750W No brakes	<140	80	35	90	4- φ7	≤55	NA	3±0.5	1±0.35	
Model \ Spec	S	LB	TP	LK	KH	KW	W	T	Weight (kg)	
750W Brakes	19	70	M6*12	25	16.5	6	6	6	NA	
750W No brakes	19	70	M6*12	25	16.5	6	6	6	NA	

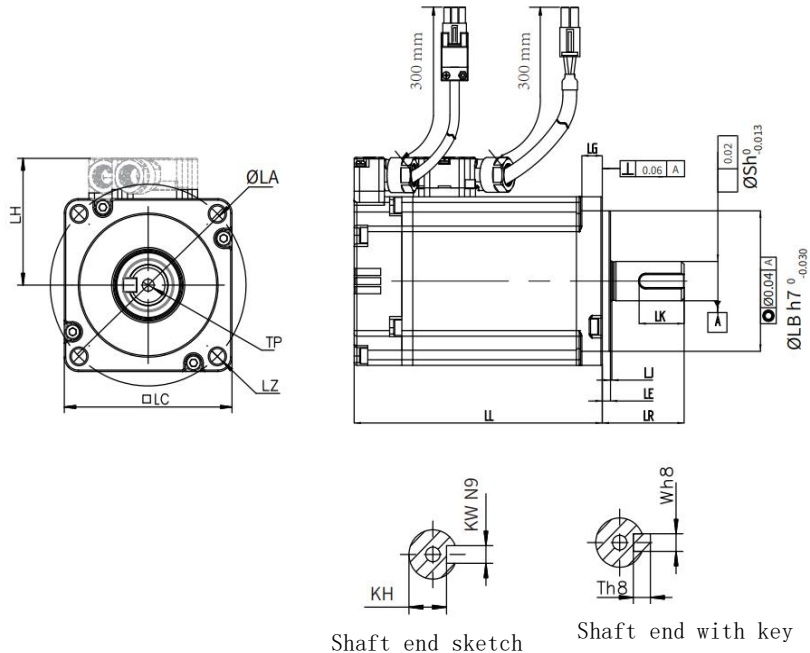

(80 Flange Motor Dimensional Drawing)

3.1.2.5 Dimensions of manual controller

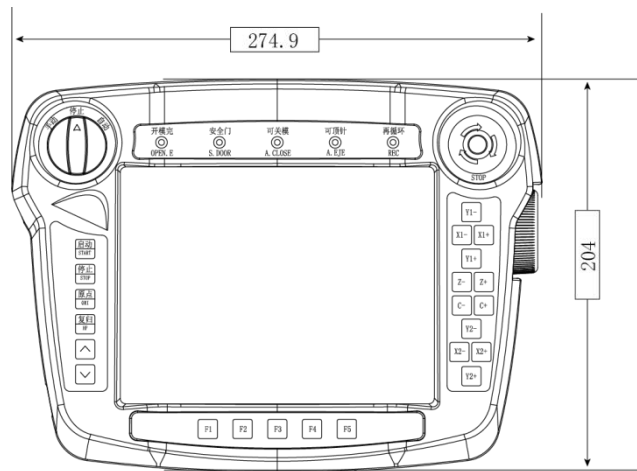

3.1.2.6 Supporting cables and specification

Cable name	Cable spec	L cable length	Cable appearance
Encoder line (4*0.25)	PMXB1-5610054	0.5M	
	PMXB1-5610254	2.5M	
	PMXB1-5610304	3 M	
	PMXB1-5610454	4.5M	
	PMXB1-5610554	5.5M	
	PMXB1-5610604	6 M	
	PMXB1-5610704	7 M	
	PMXB1-5610104	10 M	
Power line (4*0.75)	PMXB1-5640051	0.5M	
	PMXB1-5640091	0.9M	
	PMXB1-5640301	3 M	
	PMXB1-5640451	4.5M	
	PMXB1-5640551	5.5M	
Power Brake line (4*0.75 2*0.3)	PMXB1-6640251	2.5M	
	PMXB1-6640451	4.5M	
	PMXB1-6640551	5.5M	
	PMXB1-6640601	6M	
	PMXB1-6640701	7M	
	PMXB1-6640101	10M	
Manual Controller cable	PMXB1-1301050	0.5M	
	PMXB1-1301100	1M	
Manual controller cable	PMXB1-1302250	2.5M	

3.2 Power Input Definitions

Single phase 220 V power supply connection			
L1	Null	L1C	220V-L
L2	220V-L	L2C	220V-N
L3	220V-N		

Terminal identification	Terminal name	Function declaration	Remarks
L1C	Auxiliary Power Terminal	AC single phase 220V 50/60HZ	The auxiliary power supply is for internal control circuit. Main power supply line uses 3-core multi-stranded copper cable, of which single core cross-sectional area is 2.5 mm ² and insulation voltage ≥600 V
L2C			
BP	Brake Resistance Terminal	External brake resistance access point	External resistance (33 Ω 200W).
L1	Main Circuit Power Terminal	AC single-phase/ three-phase 220V 50/60HZ	The auxiliary power supply is for internal control circuit. Main power supply line uses 3-core multi-stranded copper cable, of which single core cross-sectional area is 2.5 mm ² and insulation voltage ≥600 V
L2			
L3			
U	Servo Motor Access Terminal 1-2	Connect three-phase servo motor	Connect according to the UVW corresponding access, otherwise the motor does not turn or has galloping problem.
V			
W			
PE	Ground point	Security protection access point	This point must be grounded.

3.3 I/O Port Wiring Diagram

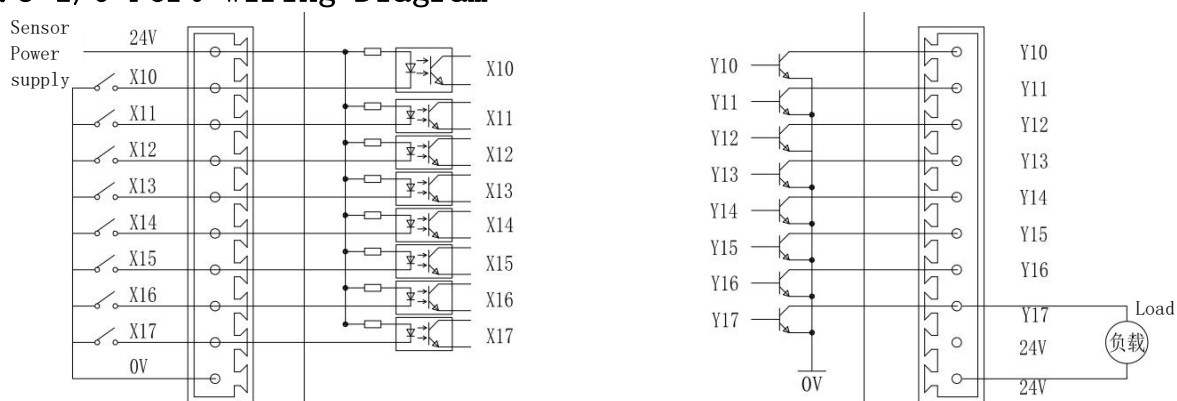

Other input signals: X20~X27, X30~X37, X40~X47

The connection is the same as in the picture above: X10~X17,

Other output signals: Y20~Y27, Y30~Y37, Y40~Y47,

The connection is the same as in the picture above: Y10~Y17.

3-axis injection molding (XYZ as servo axis, X2Y2C as pneumatic axis, no AB axes)

IO Definitions

Input	Definitions	Output	Definitions
X10	Horizontal 1 limit	Y10	Horizontal 1 vale
X11	Vertical 1 limit	Y11	Vertical 1 vale
X12	Clip 1	Y12	Clip 1 vale
X13	Clip 2	Y13	Clip 2 vale
X14	Suction 1	Y14	Suction 1 vale
X15	Suction 2	Y15	Suction 2 vale
X16	X1 end Limit	Y16	Main arm Forward vale
X17	Suction 3	Y17	Reserve 1
X20	X1 origin	Y20	Clip 4 vale
X21	Clip 4	Y21	Alarm
X22	Y1 Beginning limit	Y22	Reserve 2
X23	X23	Y23	Aid cylinders
X24	External safety zone	Y24	Horizontal 2 vale
X25	Z origin	Y25	Paint Oil
X26	X026	Y26	Standby output 5
X27	Air pressure	Y27	Mold Close Sp
X30	Sub arm forward limit	Y30	Vice Forward Valve
X31	Sub arm backward limit	Y31	Reserve 3
X32	Sub arm up limit	Y32	Reserve 4
X33	Sub arm down limit	Y33	Vice drop valve
X34	Clip 3	Y34	Clip 3 vale
X35	Y1 origin	Y35	Suction 3 vale
X36	Suction 4	Y36	Suction 4 vale
X37	X37	Y37	Conveyor
X40	X040	Y40	Reserve 7
X41	Z Beginning limit	Y41	Reserve 8
X42	Z End limit	Y42	Reserve 9 /Stop
X43	Wait X43	Y43	Reserve 10/Run
X44	Wait X44	Y44	Y044
X45	Y suction stop	Y45	Y045
X46	Wait X46	Y46	Y046
X47	External descent safety signal	Y47	Material Supply Machine
	Input emergency stop signal		Mold Open Permit
	Mold Opened		Mold Close Permit
	Mold Closed		Recycle
	Safety door		Ejection Forward Permit
	Ejection Forward		Ejection Backward Permit
	Ejection Backward		Output emergency stop signal
	Mold Inter		Core Out
	IMM Reject		Core In
	IMM Auto		
	Core Out		
	Core I		

Terminal	Definitions	Explain	Remarks
24V power port	24V	24V power	Usually used as digital input power supply 24 V±10%, maximum output current 100 mA.
	0V	Digital Input Optical Coupling Common	X10-X47 input Optical Coupling Common Interface
Input terminal	X10-X47	Connection to optical coupling	The negative electrode of 24 V power supply is effective(0 V).
Output terminal	Y10-Y47	MOS tube leakage output	Through the load to 24 V of power supply, single output protection current 350 mA, voltage 65 V. More current loads require relay isolation control
Injection molding machine output port	relay output	Always open relays	5A/250VAC/30VDC
Communication port (by type)	CAN port	Reserve	
USB monitoring port	DP/DM	USB monitoring, debugging ports	Please use manufacturer's special cable, USB electrical interface, for servo system high-performance debugging, monitoring.

3.4 Servo Motor Connection Definition

3.4.1 Power Line Definition

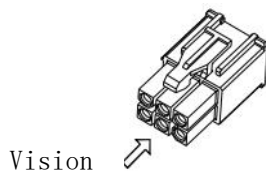

Plug: MOLEX-50361672		Pin: MOLEX-39000059				
No.	1	2	4	5	3	6
DEF	U	V	W	PE ground	NC air	NC air
Color	Red	Blue	Black	Yellow & Green		

750W below Motor power line - without brake

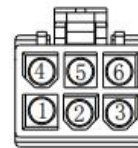
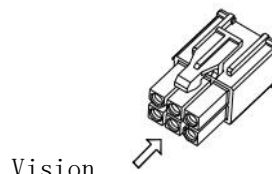

Plug: MOLEX-50361672		Pin: MOLEX-39000059				
No.	1	2	4	5	3	6
DEF	U	V	W	PE ground	Br brake	Br brake
Color	Red	Blue	Black	Yellow & Green	Brown	White

750W below Motor power line - with brake

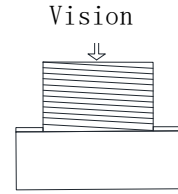
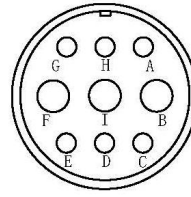
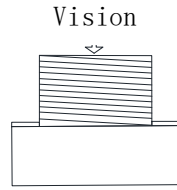
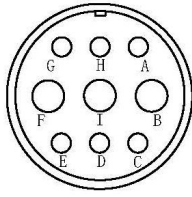

Plug model		MS3102A 20-18P/9-pin			
No.	B	I	F	G	
DEF	U	V	W	FG ground	

850W above Motor power line - without brake

Plug model		MS3102A 20-18P/9-pin				
No.	B	I	F	G	C	E
DEF	U	V	W	FG ground	Brake +	Brake -

850W above Motor power line - with brake

3.4.2 Encoder Line Definition

Host encoder DB9 interface		Motor encoder AMP-TE/female terminal/170361-1	
Pin number	Description	Pin number	Description
8	SD+	3	SD+
4	SD-	6	SD-
9	5V	9	5V
5	0V	8	0V
		7	FG
		1	Battery+
		4	Battery-

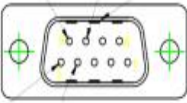

D89 Interface



Motor encoder

Note: 95、84 twisted pair

Host encoder DB9 interface		Motor encoder 17-pin aviation plug interface	
Pin number	Description	Pin number	Description
8	SD+	A	SD+
4	SD-	B	SD-
9	5V	G	5V
5	0V	H	0V
		J	FG
		E	Battery+
		F	Battery-

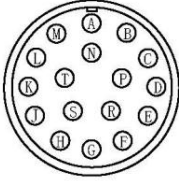

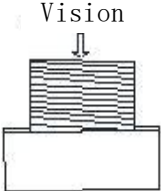

Vision

Note: 95、84 twisted pair

3.4.3 Wiring Diagram of Motor Band Brake

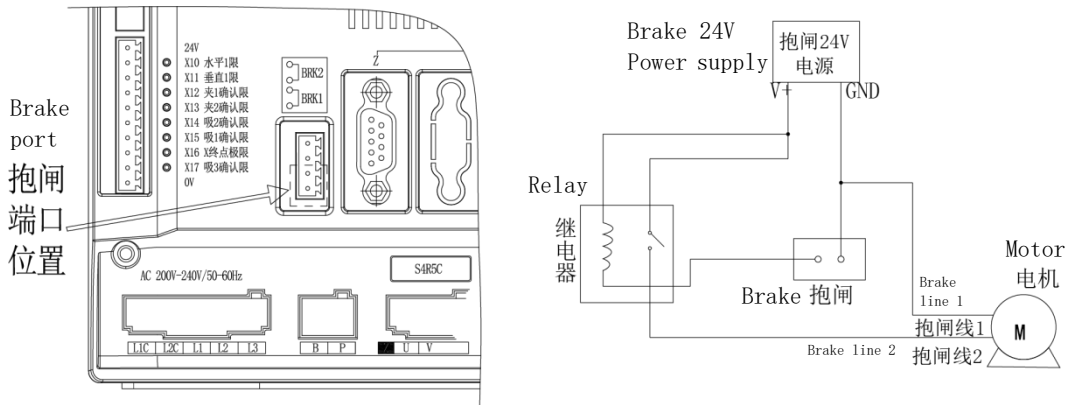

Notice: The mechanical brake port must be controlled by an external relay.

3.5 Connection of Manipulator to Injection Molding Machine

Signal wiring diagram of IMM

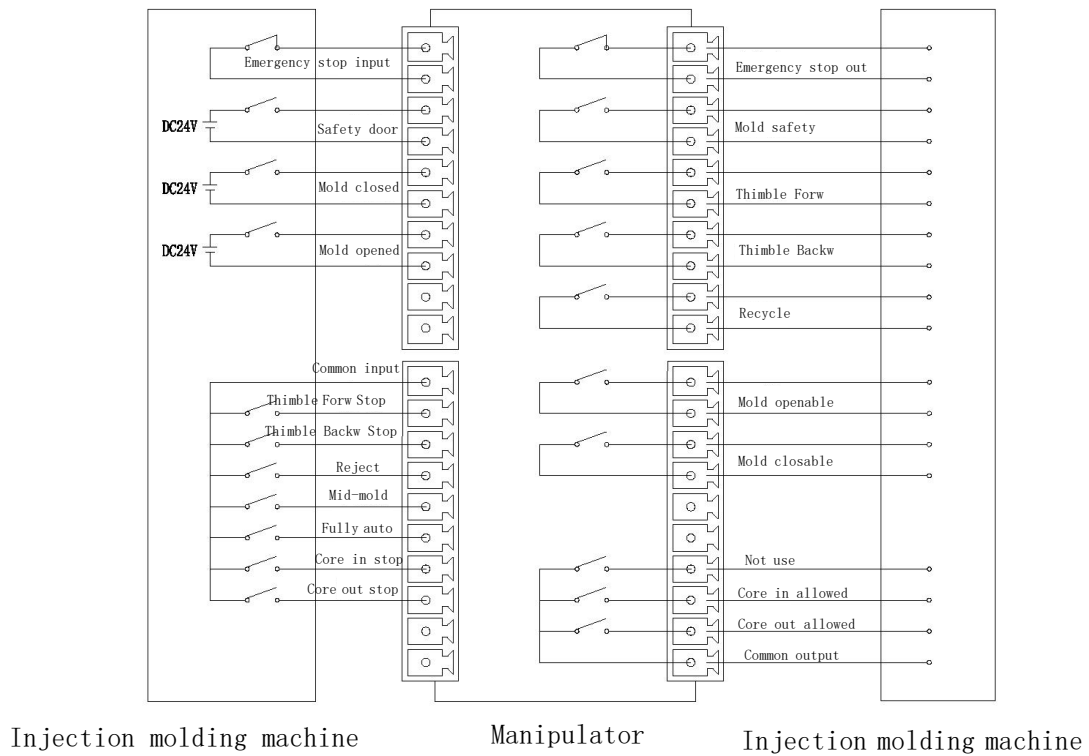

Chapter 4 Commissioning and Operation Mode

4.1 Appearance and Description

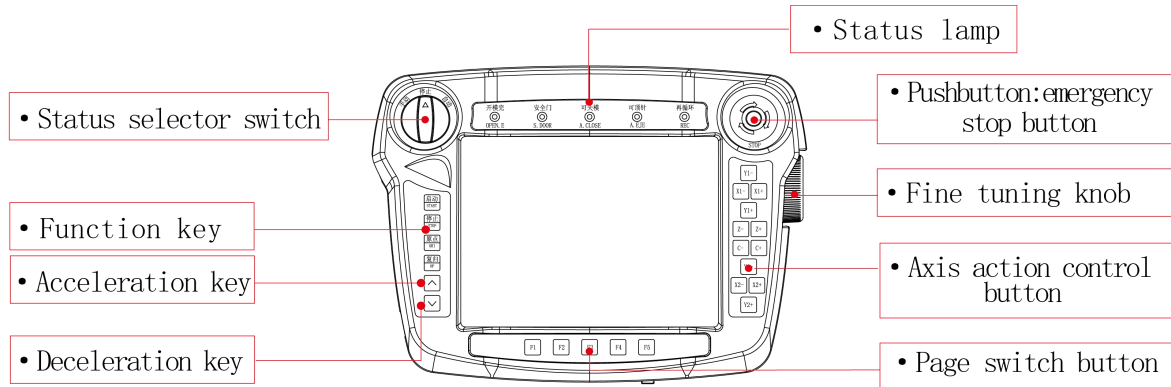

*Notice: Please refer to “5.1 Function” for details.

4.2 Main Screen

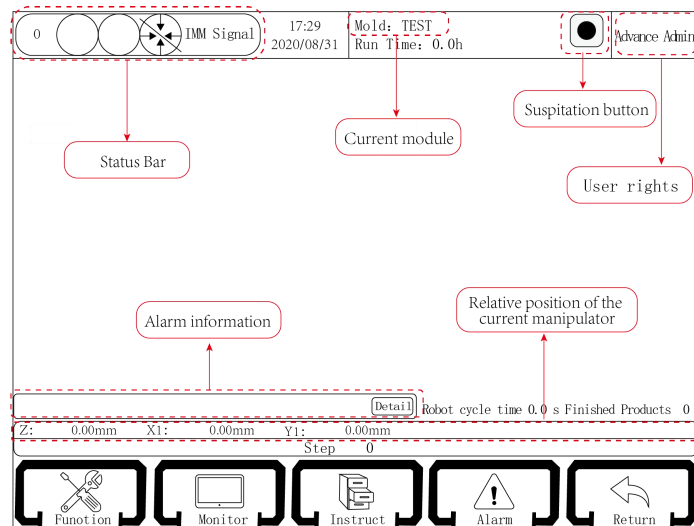

*Notice: Please refer to “5.2 Main Screen” for details.

4.3 Operation Mode

4.3.1 Pre-run Inspections

To ensure safe and correct operation, please confirm and check the following items before running.

4.3.1.1 Control host

- 1、Check connection terminals of the host and ensure them connected correctly and tightly.
- 2、Check external power supply such as input voltage and output voltage. Ensure the voltage kept in normal range.
- 3、Check the power line, encoder line and band brake line between the host and the servo to ensure that the wiring is correct and tight.

4.3.1.2 Servo motor

- 1、Check fixed parts of the servo motor and ensure them connected tightly.
- 2、Check the axis to ensure smooth rotation. (It's normal for servo motor with oil seal that the axis is tight.)
- 3、Check the power line, encoder line and band brake line between the host and the servo to ensure that the wiring is correct and tight.

4.3.1.3 Connection of input and output terminals

- 1、Check wiring of input/output terminals and ensure it correct and tight. 24V terminals and IO terminals are forbidden to access 220V.
- 2、Power on check. Enter system after the host is power on, and then confirm if there is any alarm in manual controller. If it is, clear the faulty before continuing. For servo motor with brake, please do power on check with the motor and machine apart to avoid misoperation cause by gravity or external force such as vertical axis dropping
- 3、Check output signal of band brake. Enter system after the host is power on and press the emergency stop button on the manual controller. Check whether the brake output signal is off. Then release the emergency stop button and press “STOP” to clear the alarm. Check again to confirm the brake output signal is on. When the band brake action operated correctly, connect the servo motor and machine to continue running.

4.3.2 Test Run of Servo Axis

In order to ensure the running of manipulator, it needs to confirm that the servo axes can run correctly before the first power on. Please follow these steps:

Step1: Logon senior admin permission (refer to “5.2.” for details) .

Step2: Turn on servo axis and turn status knob to STOP. Click Function to get mechanical parameters. Then open structure page to select axis definition to set X1, Y1, Z as servo axes and C as pneumatic axis. Click SAVE and exit.

Step3: Build a new program (refer to “7.1 Program Management” for details) . Name TEST and load TEST program. Then cut power off and restart.

Step4: Motor positive/negative rotation test.

Motor positive and negative rotation: Click the “Struct Settings” button on the function setting page to enter the machine parameters setting page, where you can set the parameters of each axis. After entering the page, go directly to the X axis parameter setting. As shown below:

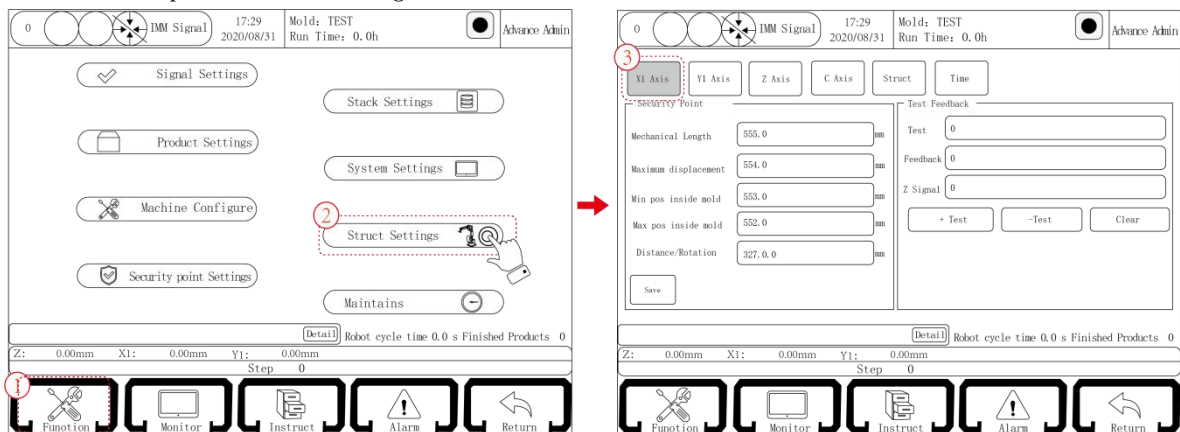

Motor positive/negative rotation test scheme: Click “Positive” and the motor will rotate a positive circle, at the same time the feedback shown is 1000; Click “Negative” and the motor will rotate a negative circle, at the same time the feedback shown is -1000.

Deal with “Motor code inconformity” It is common that alarm of motor code inconformity occurs at the first time when new machine is power on after connecting motor power line and encoder line. If restarted, that is to choose motor code stored as default selection. For products adopting absolute value mode, enter Function—Machine parameters—Struct—Servo parameter in stop state after putting battery into encoder and set param9 as 1. Then restart. (refer to “7.2.6. Servo Parameters”).

Servo parameters adjustment: Move each shaft slowly by hand. If it swings back and forth, enter servo parameter page to increase Param21 and Param22 in same ratio. If there is any abnormal sound from motor or high frequency axis vibration, decrease Param21 and Param22 in same ratio till there is only light or no vibration. 50% is commonly proper. When adjusting Param41 to eliminate vibration, increase 50% every time and 250% at most. If there is still any vibration, you can choose set Param23 as 3 or increase Param42 for 50% each time after that. When the teaching position is in automatic mid-speed running, check if there is any vibration. Execute high-speed running if without vibration, otherwise continue to adjust parameters according to step2 or increase acceleration/deceleration time of action control.

Optional optimization step: Check position deviation of servo monitoring in automatic high-speed running. Modify Param28, the max is 50 and 30 in common, to diminish deviation, that is to improve servo following performance. If there is vibration after modification, subtract 1 from Param23 and check servo torque. Increase Param30 if the torque is not over 7500, 20 at each time and 100 as default value to avoid abnormal sound from motor.

4.3.3 Origin Point Reset

In order to make the manipulator run automatically and correctly, the origin reset action will let the electric shaft of robot back to origin position, and the vacuum and fixture will return to the closed state. The homing is divided into absolute value and increment. Absolute value way is to enter “Function—Struct Settings—Struct—Origin” and check absolute servo; if not, it is increment way. It needs to click “Save” after changing reset way and turn switch to third gear to make it effective. Ensure that each axis has accurate origin position before running automatically.

(1) Absolute mode(not available in single-board injection molding system)

In manual state, use axis action button to move manipulator to the target position. In stop state, enter “Function—Struct Settings—Struct—Origin” and click “Start Origin”, then click “Set origin” to set target position as origin and the coordinate position is all 0. The system will record positions of each axis automatically before power off and it will show the previous position after restarting, so there is no need for repeated reset. Repeat steps above to set new origin position.

Steps: In stop state: Function →Struct Settings →Struct →Origin →Choose Abs Servo →Save →Start Origin →Set origin

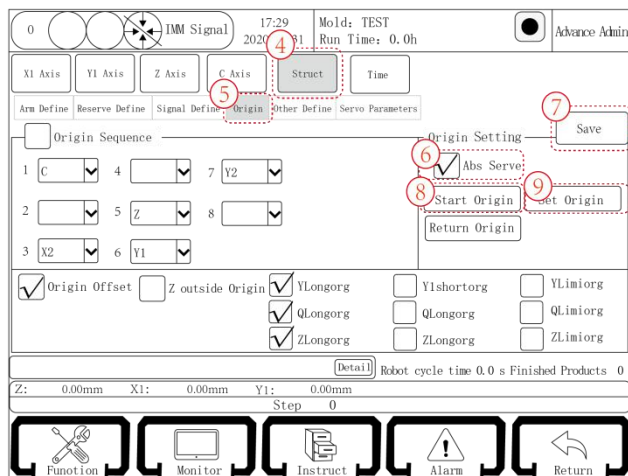
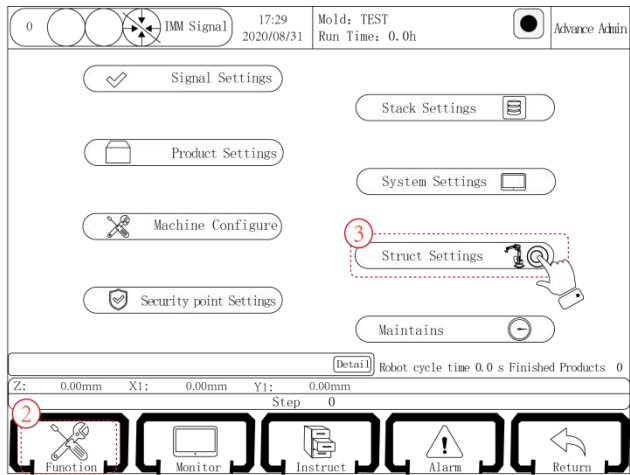
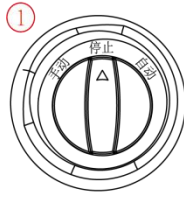

Note: Absolute value way back to origin can only use the “Start origin” and “Set origin” buttons in Function-Machine parameters-Structure-Origin set, not the “Origin” and “Start” buttons on panel.

(2) Incremental mode

After confirming that all parts of machine are normal with power on, turn the state knob to Stop and press origin button, then click start key or enter Machine parameters-Structure-Origin setting page. Click “Start origin” and press Start button on manual controller, then the manipulator will return to origin as Y1→X1→Z by default. To customize the way to return, enter Machine parameter-Structure-Origin setting page to set.

When all axes, vacuums and fixtures return to the origin position, automatic operation

and manual electric shaft operation can be carried out after the icon  at the top right of the screen turns green.

The user can not carry out manual, auto operation and set parameters while origin reset. Press Stop button to stop origin rest or press emergency stop key in case of emergency.

Note: Incremental way back to origin can use the “Start origin” button in Struct Settings--Struct--Origin and “Start” button on panel to execute, as well as using “Origin” and “Start” buttons on panel.

4.3.4 Manual Operation

Turn the status selector switch to the manual gear, and the manipulator enters the manual page, as shown below;

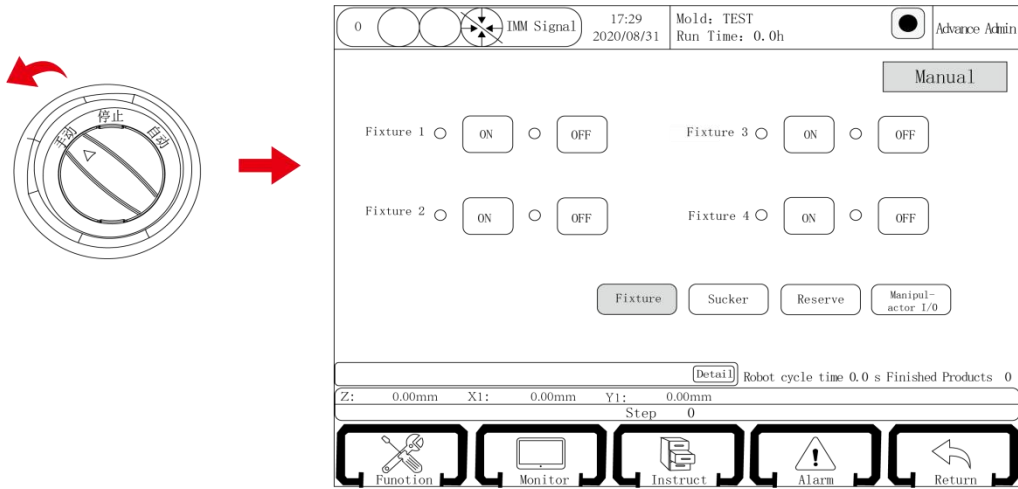

After rotating the state knob, enter the manual screen to carry on the manual operation, operate the manipulator to do separate action, and adjust each part of the machinery (confirm that there is a mold opened signal in manual state, and ensure that the mold is not touched). In order to ensure the safety of manipulator and injection molding machine, there are following restrictions:

- The manipulator can not do vertical or horizontal action after falling in the shape.
- After the manipulator drops, can not do horizontal action in the non-safe zone.
- Without mold opened signal, manipulator can not do internal descending.

4.3.4.1 Axis Manual Operation

For single-board system, the servo axis of manipulator cannot be operated before origin reset, because the positions of electric control axes are not accurate, but manual operation to pneumatic actions is allowed. For drive-control system and RTEK, both are allowed before origin rest. The max speed of servo axis in manual state can be set to 50.

- | | |
|-----|---|
| Y1- | Pneumatic: in use, the main arm rises to the starting position.
Electric: hold the key, main arm move up, and release to stop. |
| Y1+ | Pneumatic: press the key and the main arm drops to the end point.
Electric: hold the key, the main arm moves down, release to stop. |
| Y2- | Pneumatic: press the key and the jib rises to the start position.
Electric: hold the key, the arm moves up, release to stop. |
| Y2+ | Pneumatic: press the key and the accessory arm drops to the end point.
Electric: hold the key, the arm moves down, release to stop. |
| X1- | Pneumatic: press the key, the main arm back to the start position.
Electric: hold the key, the main arm moves backward, release to stop. |
| X1+ | Pneumatic control: press the key, the main arm forward to the end position.
Electric: hold the key, the main arm moves forward, release to stop. |
| X2- | Pneumatic: press the key, the accessory arm back to the start position.
Electric: hold the key, the arm moves backward, release to stop. |
| X2+ | Pneumatic: press the key and the accessory arm advances to the end point.
Electric: hold the key, the arm moves forward, release to stop. |

- C+** Pneumatic: press the key and turn the fixture vertical until the stop position.
Electric: hold the key, the fixture moves vertically, release to stop.
- C-** Pneumatic: press the key and turn the fixture horizontal until the stop position.
Electric: hold the key, the fixture moves horizontally, release to stop.
- Z-** Cross back key: hold the key manipulator moves to origin, and release to stop.
- Z+** Cross out key: hold the key manipulator moves to the end, and release to stop.

4.3.5 Teaching Page

Turn the status selection button to the manual state, then click the “Instruct” button to enter the program teaching page, as shown below:

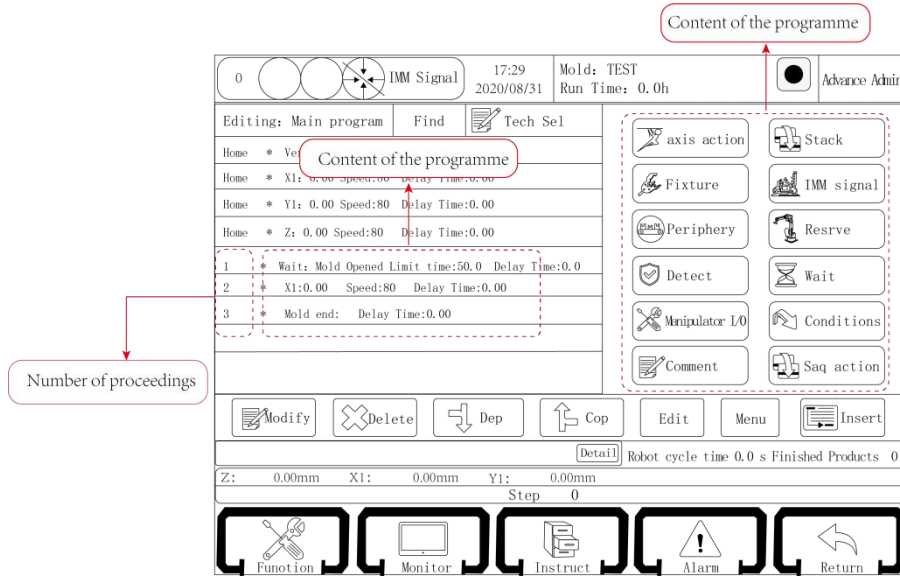

4.3.5.1 Teaching of Axis Action

Click the “axis action” button to enter the servo axis action teaching page, where the X1, Y1, Z, C axis (side pose) actions can be edited. As shown below:

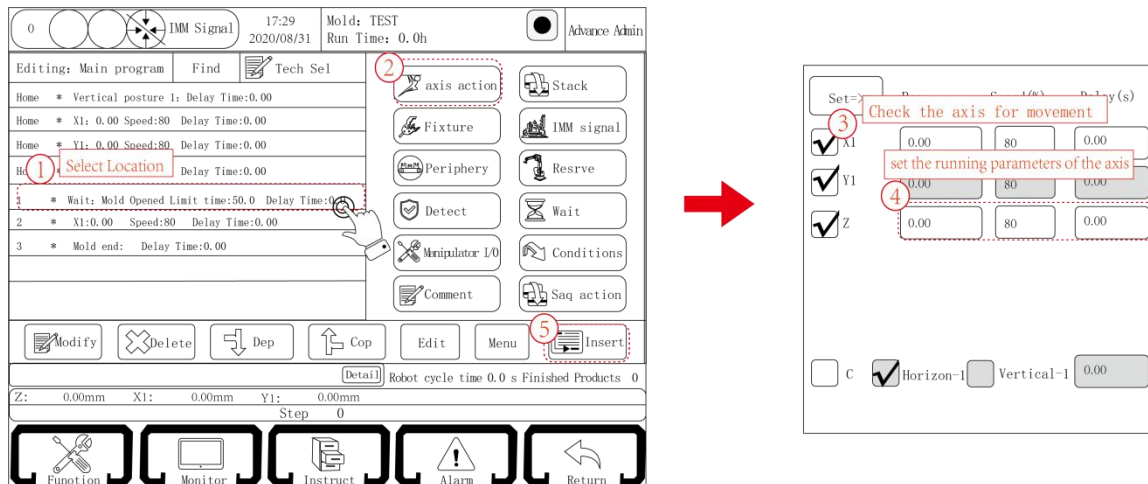

4.3.6 Automatic Status

The state selection switch is rotated to the automatic gear and the manipulator enters the automatic standby state. Press Start button again and the manipulator will start to run automatically. The operation data of the manipulator can be monitored in automatic state. The Auto Run page is shown below:

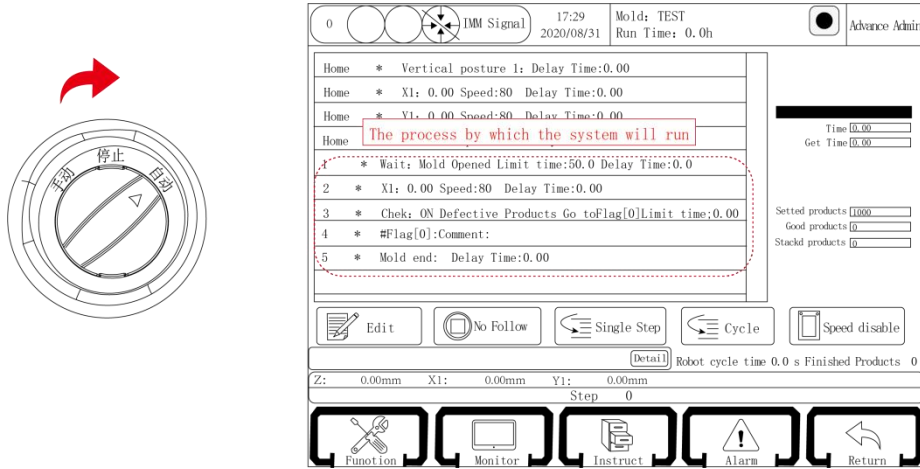

Injection cycle time: Automatically record the molding time of the previous cycle.

Fetch Time: Time from mold opened signal detected to program of mold-locked finished, that is time from the mold closable signal lamp on to off.

Setting products: Number of target output set currently.

Good products: Number of qualified products that the robot has fetched. (If no reject signal shows before mold opened, that means good product.)

Stacked products: Number of products the manipulator has stacked when using stack.

4.4 Example of Test Run:

The table below is the process of internal fetch and external put, using the default as the mold number and no modification of any default mechanical settings.

```

Home *vertical posture 1: Delay time:0.00
Home *X1: 0.00 Speed:80 Delay time:0.00
Home *Y1: 0.00 Speed:80 Delay time:0.00
Home *Z: 0.00 Speed:80 Delay time:0.00
1 *Wait: Mold Opened Limit time:50.0 Delay time:0.0
2 *X1:400.00 speed:80 Early End,End Position:150 Delay time: 0.00
3 *Y1: 250.00 Speed:80 Early Speed-Down: Speed:5 End Position:100 Delay time: 0.00
4 *Wait: EUEJFON Limit time:10.0
5 *Sucker1 ON: Delay time:0.00
6 *Clip1 ON: Delay time:0.00
7 *Y1: 0.00 Speed:80 Early End, End Position:250 Delay time:0.00
8 *X1:150.00 Speed:80 Delay time:0.00
9 *Lock Mold ON: Delay time:0.50
10 *Sucker1 Begin Detect Delay time:0.00
11 *Fixture1 Begin Detect Delay time:0.00
12 *Z:1400.00 Speed:80 Delay time:0.00
13 *Wait: X047 OFF Limit time:10.0
14 *X1:534.00 Speed:80 Delay time:0.00
15 *Y1: 713.00 Speed:80 Delay time:0.00
16 *Injection ON: Interval Mold:0 Action time:1.00
17 *Horizontal posture 1: Delay time:0.00
18 * Y1: 500.00 Speed:80 Early End, End Position:613, Delay time:3.00
19 * X1: 210.00 Speed:80 Early Speed-Down: Speed:5 End Position:123 Delay time:0.00
20 *Clip1 OFF: Delay time:0.00
21 *Sucker1: OFF: Delay time:0.00
22*X1: 150.00 Speed:80 Delay time:0.00
23 *Y1: 0.00 Speed:80 Delay time:0.00
24 *Conveyor ON: Interval Mold:0 Action time:5.00
25 *Fixture1 End Detect Delay time:0.00
26 *Sucker1 End Detect Delay time:0.00
27 *Z: 905.00 Speed:80 Delay time:0.00
28 *Mold end:Delay time:0.00

```

Chapter 5 Function Setting

5.1 Basic Function

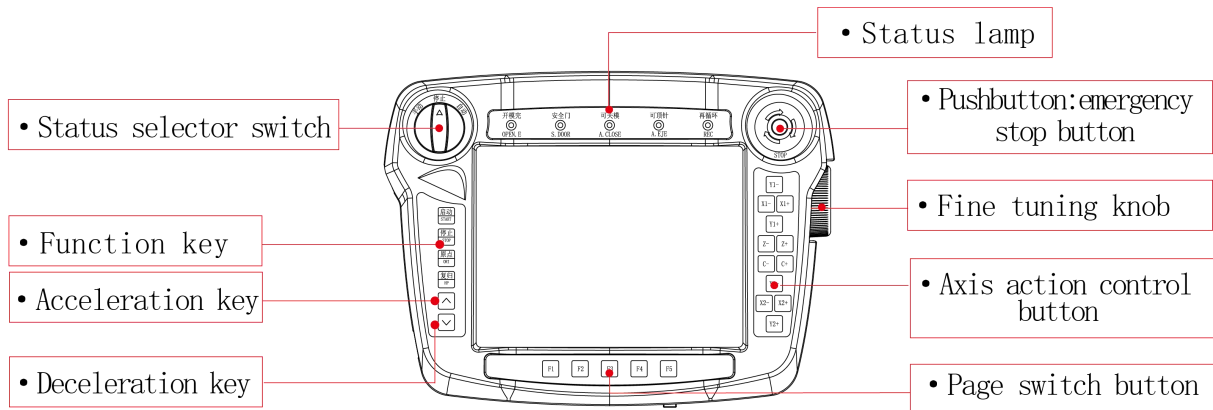

5.1.1 Function Keys

Start:

Function 1: Press “Start” button in automatic state, the manipulator enters automatic running state ;

Function 2: Press the “Origin” in stop state, and then press the “Start” key to find the origin of the manipulator ;

Function 3: Press the “Reset” key and then press the “Start” key to reset the origin.

Stop:

Function 1: Press this key in automatic state, then the program runs until the module stop.

Function 2: Press this key twice in automatic state, then the program runs this step and pauses.

Function 3: Press this key in stop state to clear the resolved alarm when alarm appears.

Origin: Only for origin reset action. Please refer to section 4.3.3.

Reset: Press this key and then press “Start” key, then all axes return to point in Y1、Z、X1 order.

Y1 back to 0 position, Z and X1 axes back to the starting point of the program.

Acceleration/deceleration key: These two keys can be used to adjust the overall speed in manual and automatic states.

Emergency stop button: Press the emergency stop button in case of emergency, it will break all the shaft energy and the system sends “emergency stop” alarm. Turn out the knob and press “stop” button to eliminate the alarm.

5.1.2 Fine Tuning Knob

Function: Used to move shafts in accurate positioning under manual state.

How to operate: Click the button and check “Handwheel selection” to select the hand wheel speed and the axis that needs to be fine-tuned, or press the axis key that needs to be fine-tuned (on the manual controller). Then scroll the fine-tuned knob to move the axis to the target point.

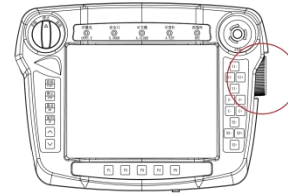
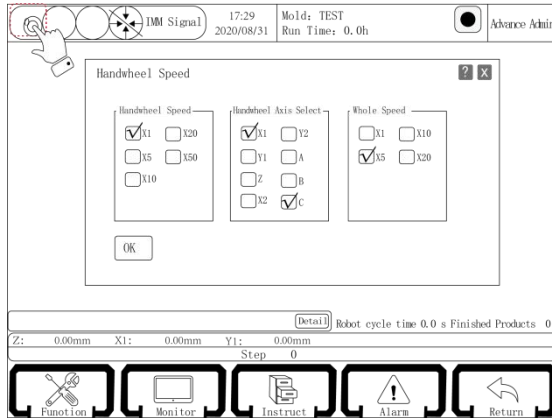

Hand wheel speed description:

X1: move a lattice axis translation 0.01 mm or axis rotation 0.01 degrees.

X5: move a lattice axis flat 0.05 mm or axis rotation 0.05 degrees.

X10: move a lattice axis flat 0.1 mm or axis rotation 0.1 degrees.

X20: move a lattice axis flat 0.2 mm or shaft rotation 0.2 degrees.

X50: move a lattice axis flat 0.5 mm or axis rotation 0.5 degrees.

5.2 Main Screen and Axis Definition

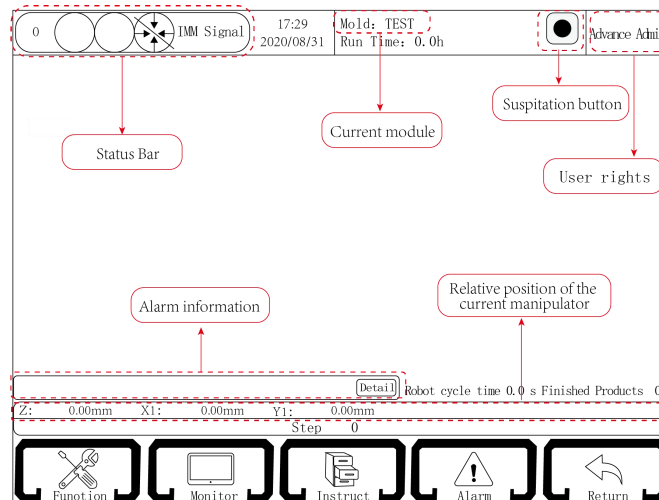

Status bar: Gray indicates that not return to origin, green indicates that has returned to origin.

Current module: Display according to the mold number established by different processes. Can be created, copied, deleted, loaded, exported in the file.

Suspension button: Auxiliary buttons are virtual keys to provide auxiliary measures for manual controller entity keys. There are start, stop, origin, return, acceleration, deceleration, hand wheel-, hand wheel+, manual, stop, automatic and servo parameter monitoring keys.

User admission: Able to log on as operator, administrator and senior administrator. The initial passwords is 123.

Current axis position: Display the coordinate position of the current machine in real time.

Alarm information: Display alarm information when alarm occurs. Press the help button then it will pop up the solution dialog box. Follow the notice to solve problems.

5.3 State Knob

The manipulator has three operating states: manual, stop and automatic. The state selection switch is rotated to the left gear as manual state, in which the manipulator can be manually operated; the state selection switch is rotated to the middle gear as stop state, and the manipulator stops all actions in this state. Turn the state selection switch to the right gear and press the start button once, then the manipulator enters the automatic running state.



Chapter 6 Manual Status

6.1 Operation of Manual Pages

6.1.1 Fixture Page

Click the button “fixture” and “sucker” buttons in the lower right corner of the touch screen to enter the manual operation page of the fixture, as shown below:

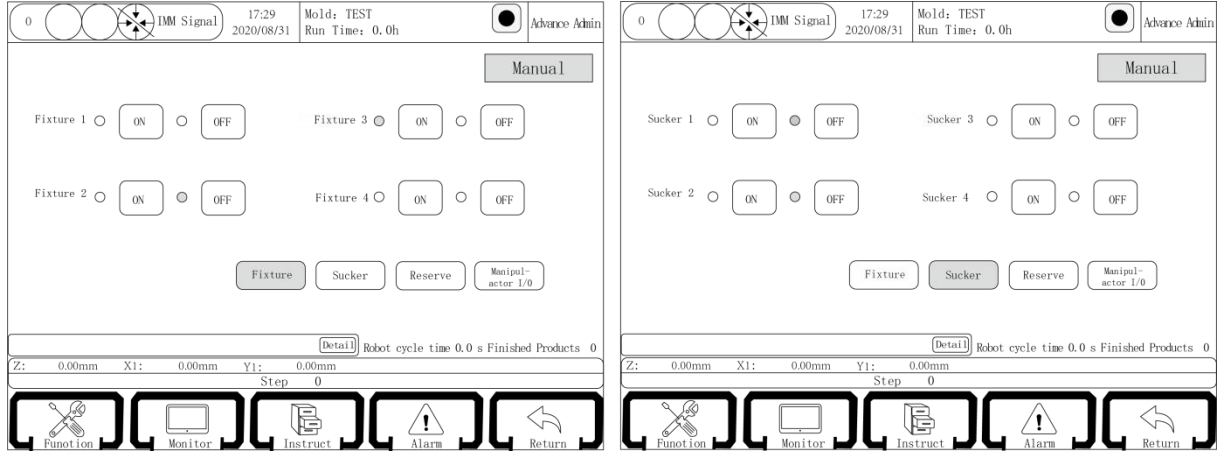

There are two kinds of fixtures, “fixture” and “sucker”, four groups for each. Click the button “ON” and the corresponding tool signal output. Click the button “OFF” and the corresponding tool signal is disconnected.

Note: The red light is the input limit signal and the green light is the output signal.

If there is no signal input or output, the indicator is gray.

6.1.2 Manual Operation of Auxiliary Equipment

Click the “Manipulator I/O” button in the lower right corner of the touch screen to enter the manual operation page of the auxiliary device, as shown below:

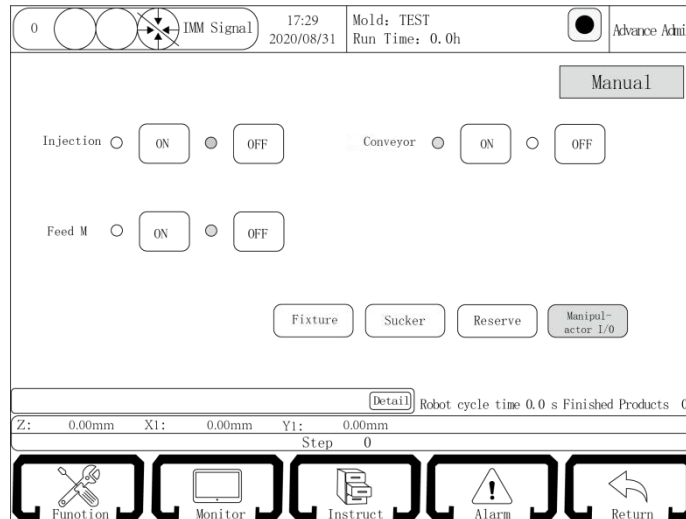

Click the injection button “ON” and the injection output point is ON. Click the button “OFF” and the injection output point is disconnected.

Click the conveyor belt button “ON” and the conveyor belt output point is ON. Click the button “OFF” and the conveyor belt output point is disconnected.

Click the Feed Machine button “ON” and the Feed Machine output point is ON. Click the button “OFF” and the Feed Machine output point is disconnected.

6.1.3 Manual Operation of Reserve Action

Click the “Reserve” button in the lower right corner of the touch screen to enter the manual operation page of the reserved action, as shown below:

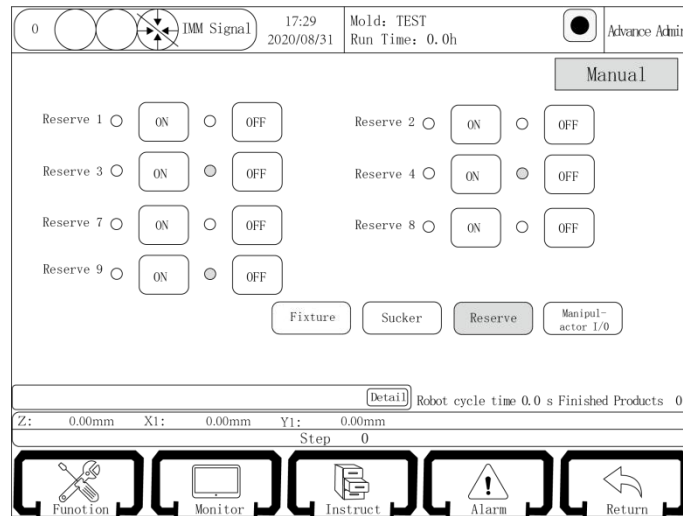

Click the button “ON” and the corresponding reserved point signal output is on. Click the button “OFF” and the corresponding reserved point signal output is off. The system has six sets of fixed reservation and two sets of optional reservation (Reserve 9 and Reserve 10 can be set in the reservation setting). Users can choose according to their needs.

Warn: Reserve 1 and Reserve 2 can be checked without interlocking and the output of one does not affect the other. If not checked, the default Reserve 1 and Reserve 2 interlock, that is, the output of Reserve 1 will be cut off if Reserve 2 is on after Reserve 1. Please connect carefully if there is a need! (Interlocking and reservation functions can be set in reservation settings)

6.2 Teaching Page

Turn the status selection button to the manual state, then click the “Instruct” button to enter the program teaching page, as shown below:

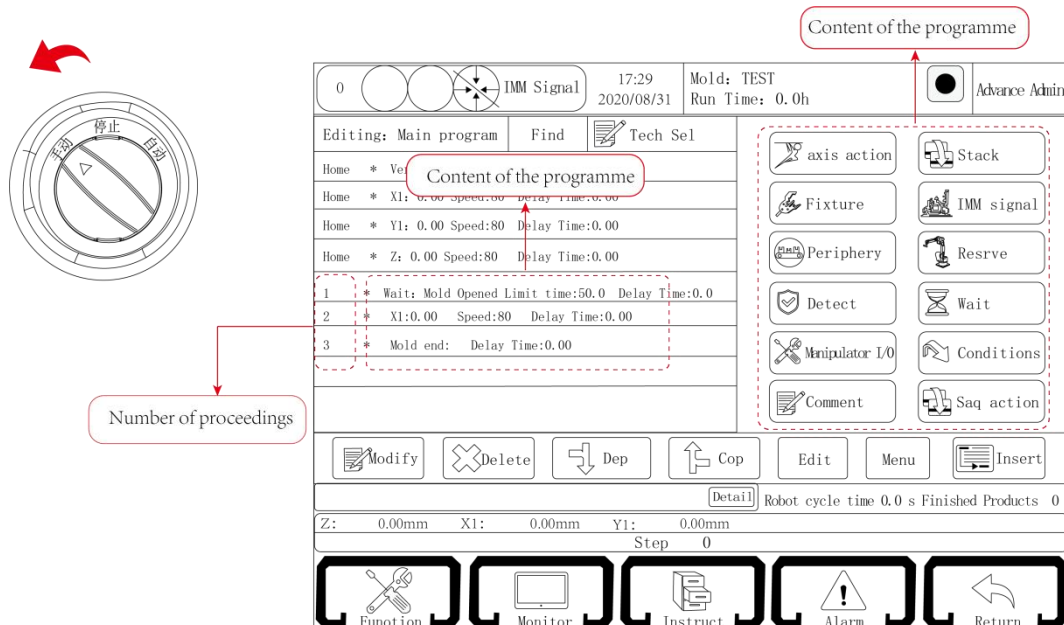

Menu: The action menu divides the program editing into 12 kinds. Click on the corresponding button to enter the teaching page for that type of action, and click the “Main Menu” button to return to the main screen of the teaching action. (If there are no conditional and sequence action buttons in the main menu and no quick settings on the left side of the teach selection, please set them in the advanced administrator)

Edit: Select the action and click the Edit button to modify the parameters of the action.

Delete: Select action, click Delete button, then this action is deleted.

Cop: Select Y1, click Cop in the figure above, then the Y1 axis step order becomes 3. Y1 and X1 axis start running at the same time in automatic running.

Dep: After decomposing two actions, actions running together will run as sequence.

Function: Click the Function button to enter the function page, as shown below:

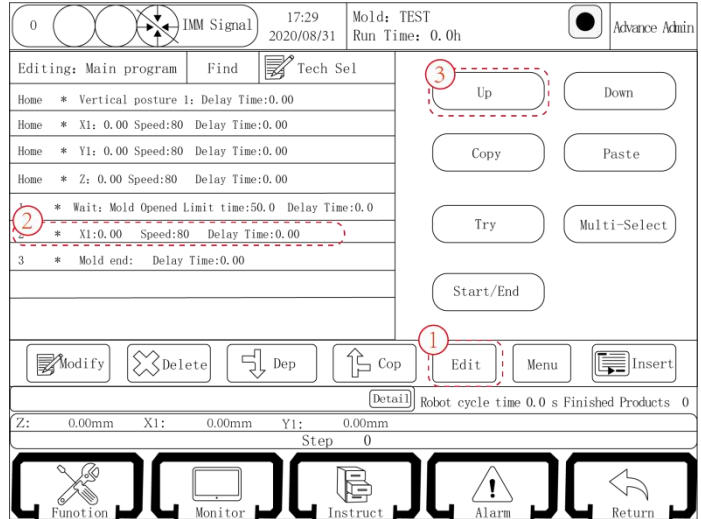

- 1、Up: Select step 4 above, click “up” button, it will move up, step order turns to 3.
- 2、Down: Select step 2 above, click “down” button, it will move down, step order turns to 3.
- 3、Copy, Paste: Select step 4 above, click “copy” button, then select step 2 and click paste button, it will be above step 2.
- 4、Try: Click one action, hold “Try” button to execute the action and release to stop.
Warn: Due to the trial run function can not follow the sequence of procedures. Please pay attention to anti-collision when using!
- 5、Multi select: Click Multi-Select cables to select. “start / end” button are able to click. Select step 2, click start key, click step 4, and click end key, step 2-4 are selected.

Insert: Check an action, select the position to insert, click the insert button to teach the action to the desired position.

Find: 1) Click the Find button and enter the Find page, as shown below:

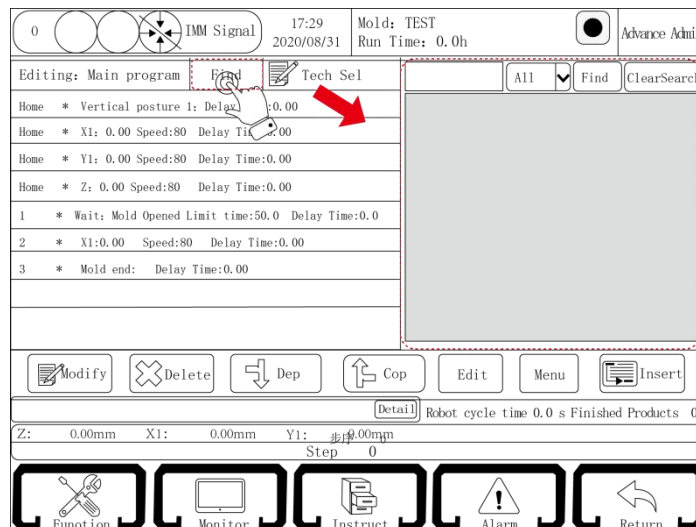

- 2) Enter the keyword you want to find in the left input box. To view all the actions related to 1, you can enter “1” directly, then select the search range as all, and then click the “Find” button to appear all the actions related to 1, as follows:

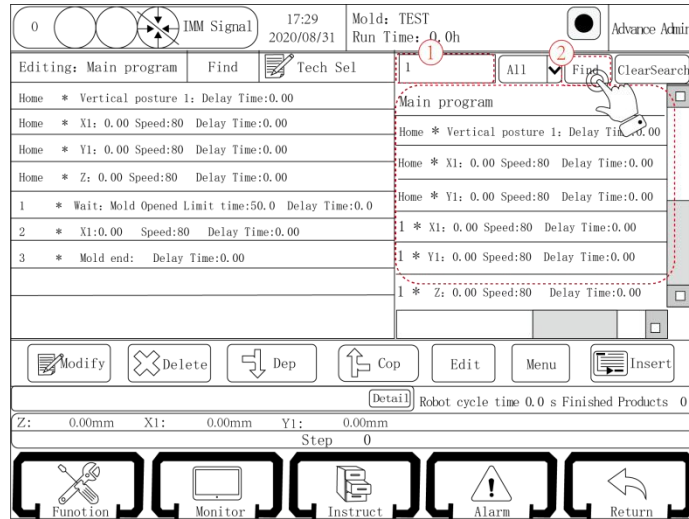

- 3) Click the action searched, you can jump directly to the action where the program and click the Clear Search button to clear the content.

- 4) In this system, we need to teach an action to the program, check the box on the left side of the action, select the program step on the left side of the page, and click “insert”. The indicator is green to indicate the corresponding valve output.

If there are no special circumstances, please note the following two points:

1. The time set by the delay is the time to wait before the action is performed, and when waiting for the action, the next program will not be run.
2. The interval modules is to perform an action once every few molds in the automatic state running time.

6.2.1 Teaching of Axis Movement

Click the “axis action” button to enter the teaching page of the servo axis action, where the X1、Y1、Z、C axis (side pose) action can be edited. As shown below:

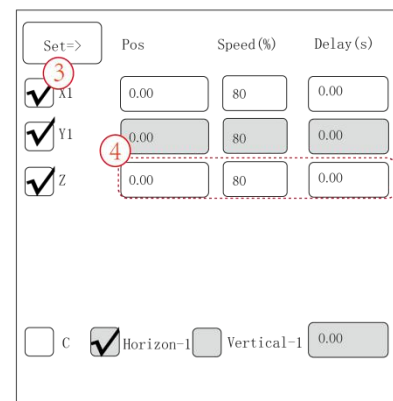
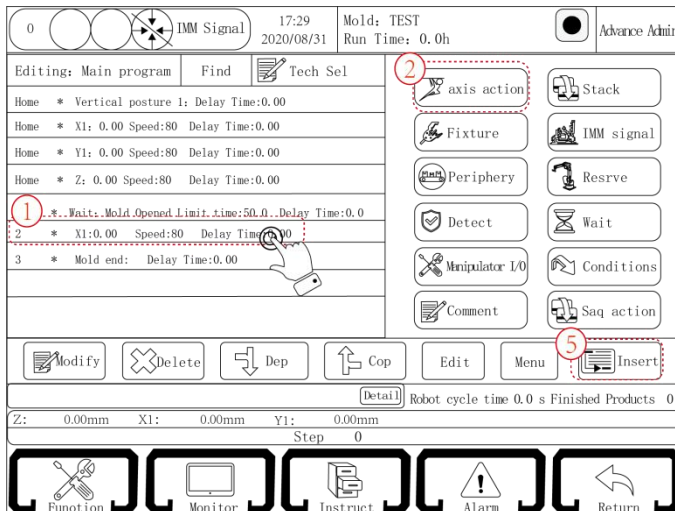

The position, speed and delay time of the servo axis can be taught on this page, and the horizontal or vertical state of the pneumatic axis can be selected.

There are two ways to set the position of the servo shaft:

1. Enter the coordinate value of the target position directly in the text box of the position.
2. Press the manual axis action key to move the axis to the target position, then click the “set in” button to set the current position of the axis to the text box.

6.2.2 Teaching of Program Starting Point

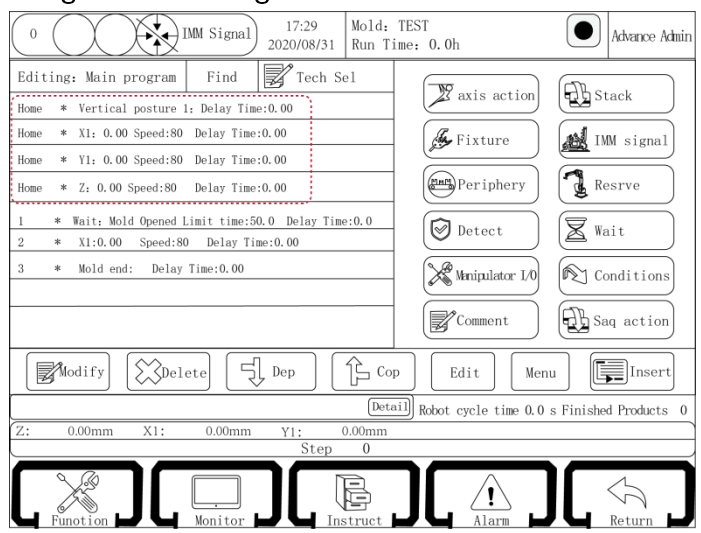

The starting point display corresponds to the axis definition “machine parameter and safety point setting”, that is, the number of chosen starting points is the same as number of axes. If the numbers or types of axes in the starting point and axis definition are different, it will alarm “the standby point position error”. Then it needs to create new mold number or choose correct axis definition.

Note: The starting program can be edited but can not be deleted.

6.2.3 Stack Instruction

Stack editing, as shown below:

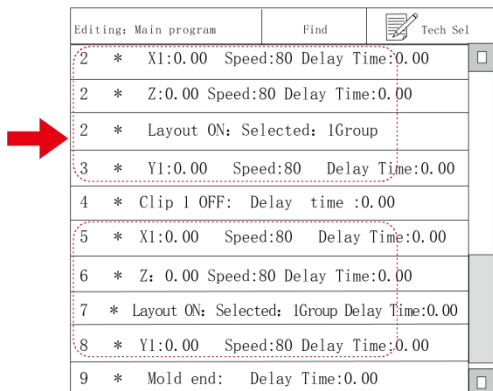
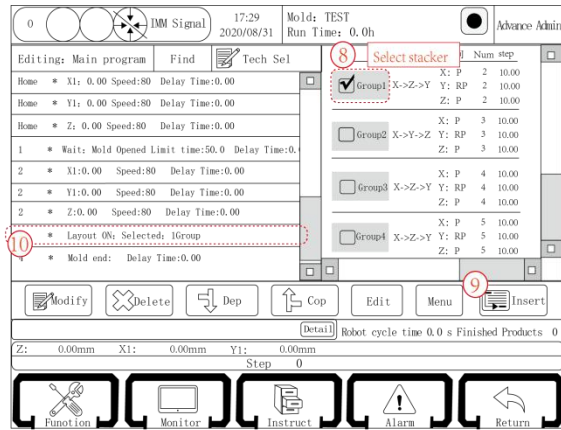
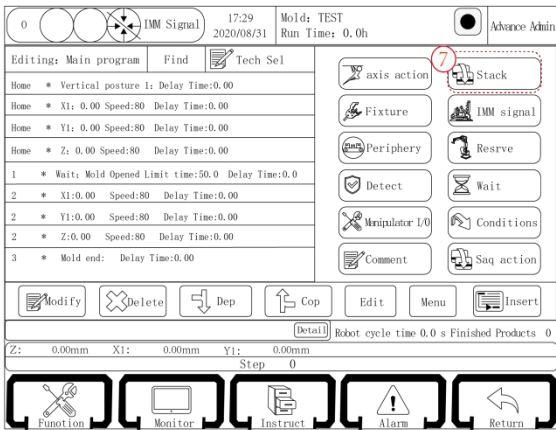
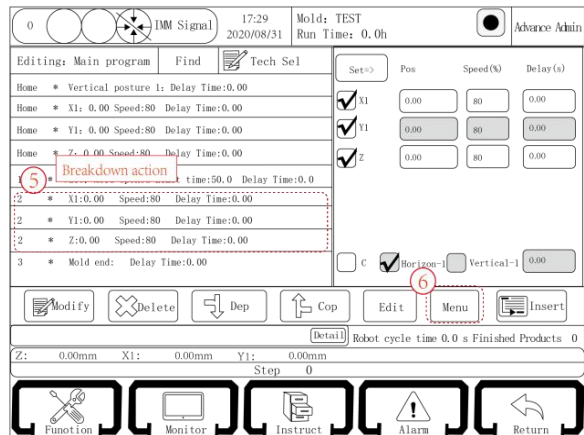
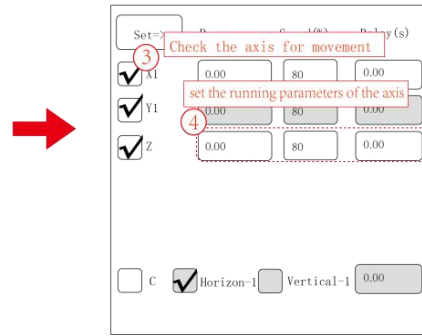
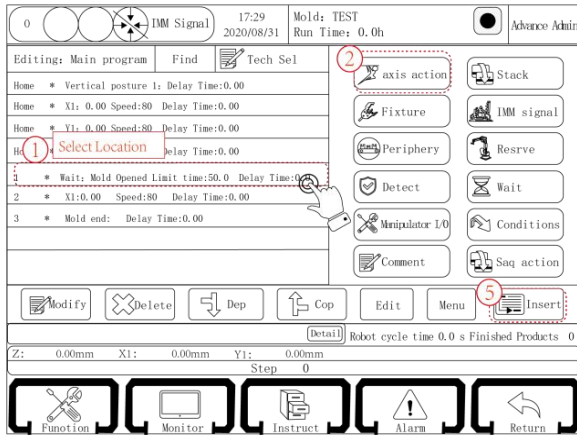

By Function, Up, Down, Decompose, Compose and other keys, the stack program can be set as two kinds shown on the left:
 Notice:
 1. Z axis, X axis and stack program must be combined together.
 2. Y axis action must be next step to stack program.



Scan the QR code for accurate stacking course.

Check the box on the left of the stacking program to be inserted, e.g. select the 1st stacking program, then click the “Insert” button to insert the stacking program before the program step that is going to start stacking, and the robot will stack the discharges according to this stacking program when it runs automatically. If you want to use the Y axis for stacking, be sure to insert the stacking program one step before the Y axis descent action. Each automatic program can insert 7 groups of stacking programs, which can be stacked in 7 different positions to discharge products; when using stacking 7 groups of stacking, the starting position of all 7 groups of stacking should be 0.

Important: The Y axis is selected in the system design as the end between stacks. The stacking procedure must be inserted before the Y axis action. If there are multiple stacks, the Y axis must be inserted between the multiple stacks to isolate them.

6.2.4 Teaching of Fixture and Detection Program

The following are “Fixture” and “Detect” pages, “Fixture” and “Detect” functions are usually used together, where actions can be set. As shown below:

The screenshots illustrate the process of configuring a fixture and detection program. The first screenshot shows the main program editor with a 'Select Location' button highlighted. The second screenshot shows the 'Fixture Action' dialog box with 'Fixture1' selected. The third screenshot shows the 'Detect' dialog box with 'Sucker1 detect' selected. The fourth screenshot shows the final program steps, including 'Wait: Mold Opened Limit time:50.0', 'Clip 1 ON', 'Sucker1: OFF', and 'Fixture1 BeginDetect'.

The controller can control four groups of fixture, four groups of suction cup action and the teaching of fixture and fixture detection function. For coaxial action teaching, detection program should be taught after the fixture action.

When running to the jig on in automatic running, the jig fetches the item, and when running to the action of “jig start to detect”, if the corresponding jig confirms that the limit signal state is correct, the program continues to run, otherwise the alarm “take the item failed” and a pop-up box appear. If click the “Give up” button in the pop-up box (at this time the Y axis is at the home position), the program will return to the starting position and fetch the item again. If click “Continue” button, the program will continue to run to the next step. When running to jig off, the tool will put the item, and the “Jig off” action will detect relative confirmation limit signal in about 1s. If the signal is correct, the program will continue, otherwise the alarm will be “Fetching failure”.

Important: When the output of the fixture is cut off, the system will delay 0.5 S before detecting the signal. If there is still a signal in the fixture detection, the system will alarm. If the teaching program is finished, the system no longer detects whether the fixture has a signal. When the detection signal is normal, there is no need to teach the detection end signal!

Warn: If the same fixture action in the program requires several on/off actions, the end detection must be taught. For example: In Suck 1 ON, Suck 1 OFF, Suck 1 ON, Suck 1 OFF, it needs to teach end detection in the first Suck 1 OFF.

Please do teach fixture and suction cup detection, otherwise the module may be damaged.

Tip: Because the negative pressure detection switch action takes time, and the program running speed is within 1 μ s, if to teach the detection action immediately after the fixture action, the system will alarm the failure of fetching.

Solution:

1. Put the detection action after the rise (after a few steps).
2. Delay start detection, generally more than 0.5 S. It does not affect the cycle.

6.2.5 Teaching of IMM Signal

Click the “IMM Signal” button to enter the signal editing page of the control injection molding machine, where the control injection molding machine lock, thimble, core pulling action can be set. As shown below:

Enable	Cur	Delay
<input checked="" type="checkbox"/>	● Mold close EN	0.50
<input type="checkbox"/>	○ Ejection EN	0.50
<input checked="" type="checkbox"/>	● Ejection backward enable	0.50
<input type="checkbox"/>	○ Core1 EN	0.50
<input checked="" type="checkbox"/>	● Core1 Out EN	0.50
<input type="checkbox"/>	○ Core2 EN	0.50

The indicator light is green for ON and gray for OFF. Teach an action on, then the signal starts to output. Teach an action off, then the signal stops output. “Ejection EN” and “Ejection backward enable” don’t cost cycle time.

E.g. Set the “Ejection EN” delay to 5s, then program will not stay in this step but directly run to the next program and start output after 5s.

6.2.6 Teaching of Auxiliary Equipment

Click the Periphery button to enter the edit page of the auxiliary device. As shown below:

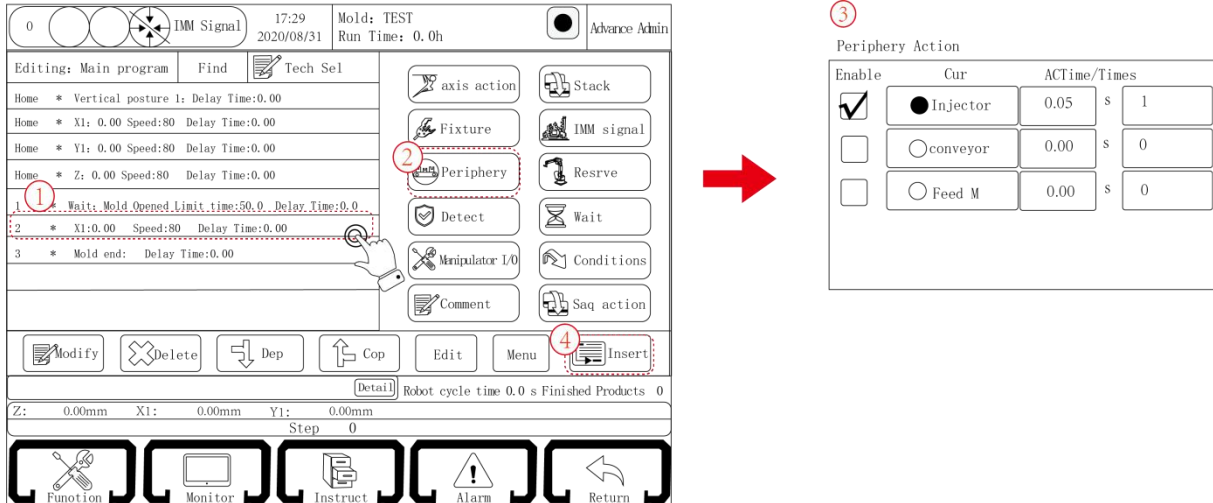

Time: Set the execution time of this auxiliary device, the auxiliary device is all time control, just teach the through action and reach the set execution After reaching the set execution time, the output will be automatically disconnected (the time will not occupy the cycle time at this time).

The number of interval modules: The auxiliary device outputs every few modules during the automatic operation. If the interval module is set as 3 and the execution time is 5s, the auxiliary device will output every 3 modules during the automatic operation, and will be automatically disconnected after every 5s.

Note: The actual count of the conveyor belt is related to the conveyor belt counter.

For details, see the description of the belt counter in the product settings.

6.2.7 Reserve Instruction

Click the “Reserve” button to enter the instruction page for reserved actions, as shown below:

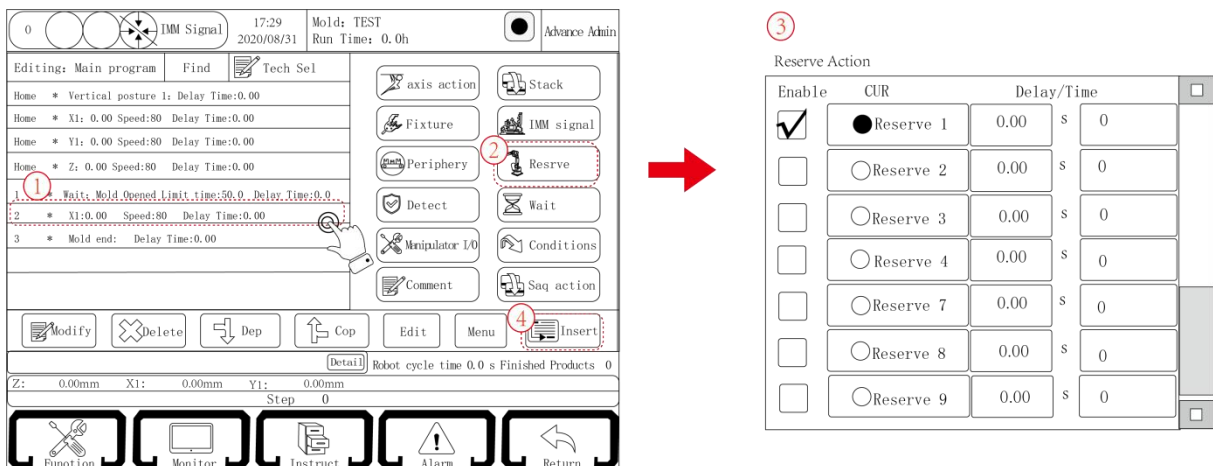

This system sets up 8 groups of reserve output points. If the program teaches the reserved action, when running automatically, after running to the reserved pass action, the reserve point starts to output, after running to the reserve break action, the reserve point disconnects the output.

Warning: Reserve 1 and Reserve 2 can be checked without interlocking and the output of one does not affect the other. If not checked, the default Reserve 1 and Reserve 2 interlock, that is, the output of Reserve 1 will be cut off if Reserve 2 is on after Reserve 1. Please connect carefully if there is a need! (Interlocking and reservation functions can be set in reservation settings)

6.2.8 Wait

Click the “Wait” button to enter the teaching page waiting for the input signal, insert the waiting input signal, automatically run to the step, only when the input point has signal input or no signal input can perform the next action. As shown below:

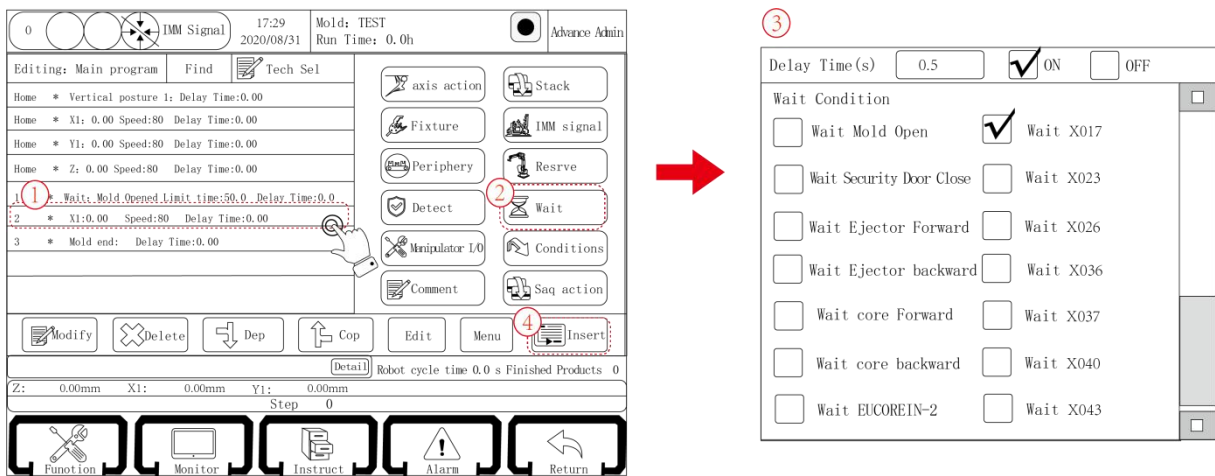

Each automatic running program must contain “Wait Mold Opened” program step. A new program already contains this program step by default and it cannot be deleted.

The waiting action can be inserted into the main program after the waiting time, ON or OFF is set in the delay box of the waiting page, or after the waiting action is inserted into the program, the waiting action can be selected, and then the edit button can be clicked to modify the time limit.

Limit Time: When program executes the waiting step, if the waiting signal is on and the limit time is set as 10 s, it will alarm after the waiting signal keeps longer than 10s in automatic running. If there is a signal input within 10s, the program continues. Wait mold opened limit time can only be set in “Edit” - “Product Settings” - “Wait Mold Opened Limit Time” function.

6.2.9 Manipulator I/O

Click the “Manipulator I/O” button to enter other pages for teaching.

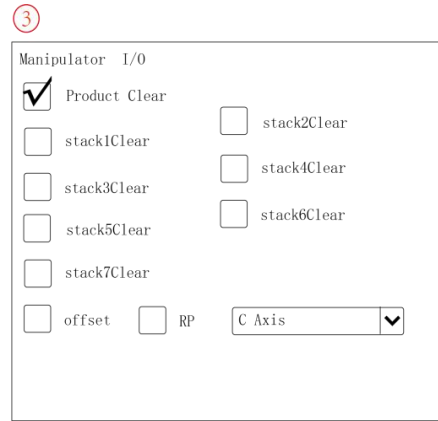
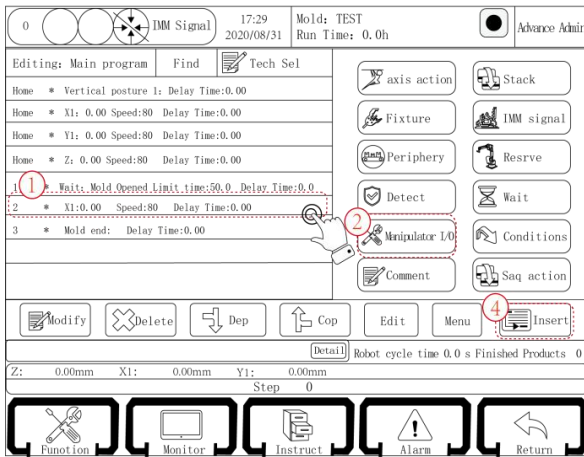

Product clear: This function is inserted into the program, automatically run, each time this step, the system will complete the product number zero, start counting again.

Stack clear: If this function is inserted into the program, automatically run, each step, the system will set the corresponding stack group zero, start counting again.

Offset preparation: Select offset preparation and set offset positive/negative direction (positive if negative is not checked). Select axis that needs to be offset, such as X1 axis, then click insert to teach X1 axis action after bias action. The action here is to move a relative position.

6.2.10 Sequence Action

Click “Sequence action” to enter the page.

The sequence action is divided into the main arm internal fetching and the sub arm internal fetching, as shown below. This function is to take a series of actions of internal fetching as a secondary program to form a program block, in which the complete movement of internal fetching can be done.

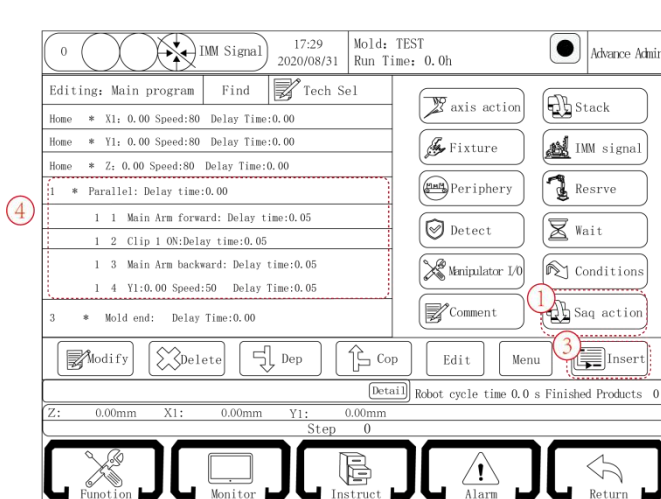

The common use is to combine the two sequence actions as shown in the following figure. Because each sequence completes a series of actions, the two series of actions are executed at the same time, and the secondary program in the sequence does not interfere with each other, the main and sub arms can be independent but complete the fetching action at the same time.

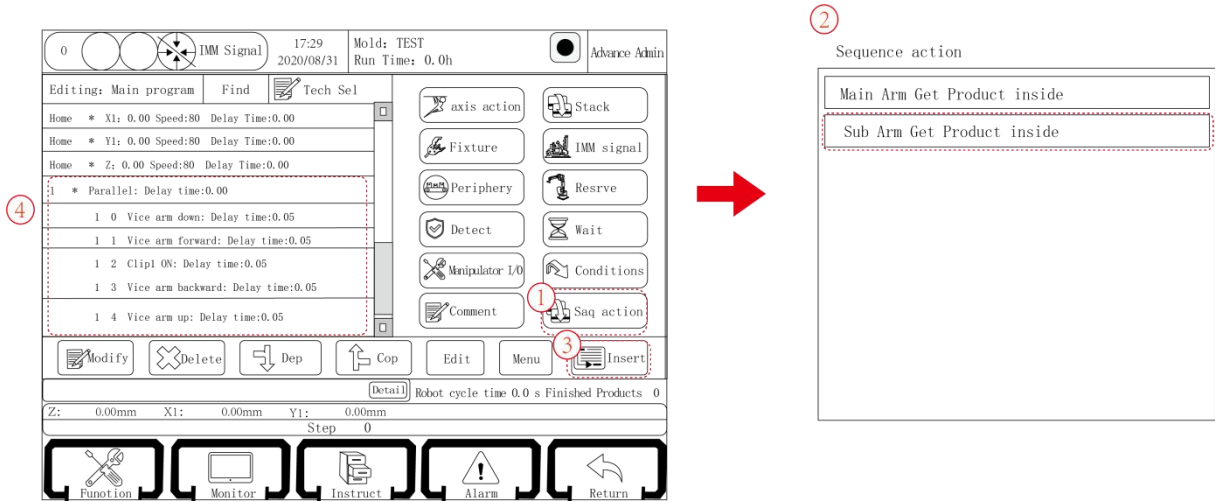

6.2.11 Program Quick Setting

Click on the Guide to enter the quick settings page. (This feature needs to be turned on in System Settings – Senior Administrator)

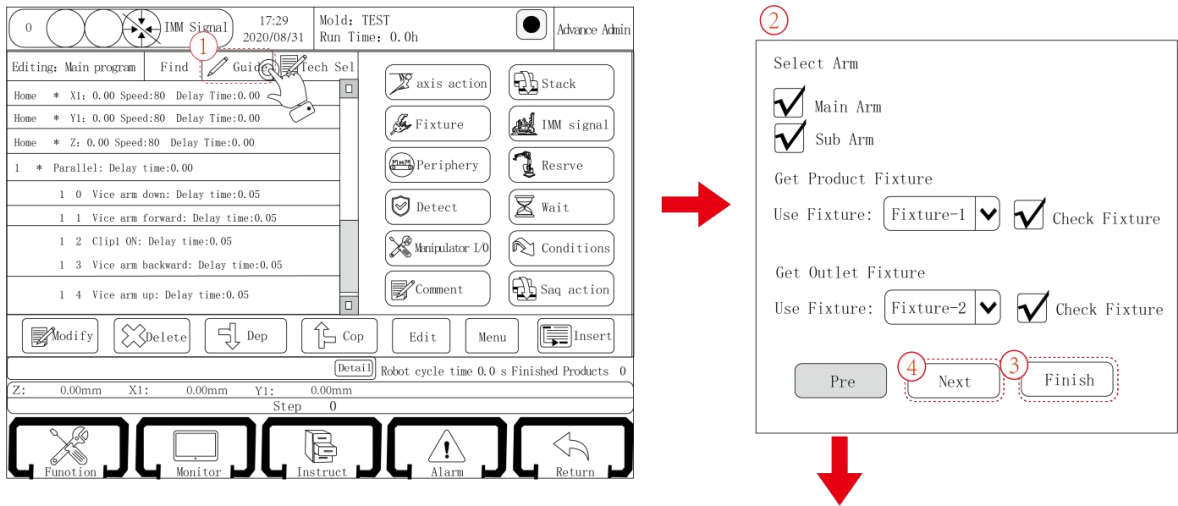

As shown above, it can only set the position and select actions. The program can automatically generate executable programs, eliminating the tedious teaching.

Warning: If this function is pressed by mistake, it is possible to make the position all set as 0. Please pay attention to distinguish and inform the customer!

6.2.12 Comment

Click the “Comment” button to enter the annotation/label instruction page. After inserting the annotation, it can explain the previous program or the next program. At the same time, you must insert “Comment” before inserting the condition into the main program. (If conditions of use must insert “Comment”)

Click on the blank bar of the comment, the input box will automatically pop up, enter the comment content in the box (click CH to switch between Chinese and English), then click the ENT key, and then insert the comment before the corresponding program step. The input box is as follows:

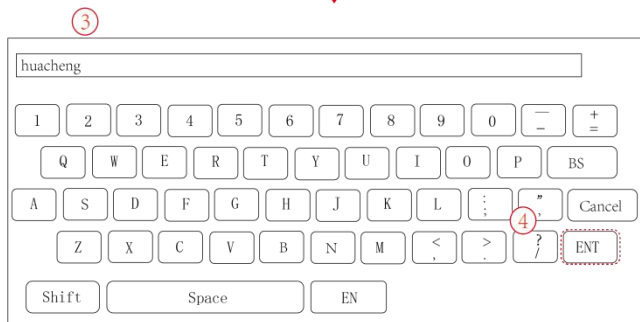
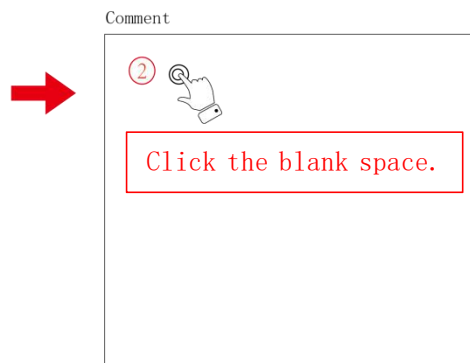
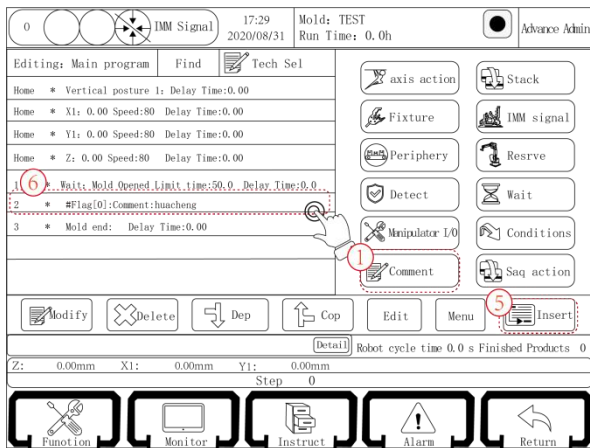

Enter annotation by keyboard.

6.2.13 Condition Teaching

Click “Condition” to enter condition teaching screen. Choose signal “X43” and check limit “OFF” as condition. Insert the condition into exact position in main program. When the sequence is executed, enter subprogram to execute relative actions if no signal is detected and jump back to label position in main program when it is done. If the signal is detected, continue executing actions of main program and do not jump. As following pictures:

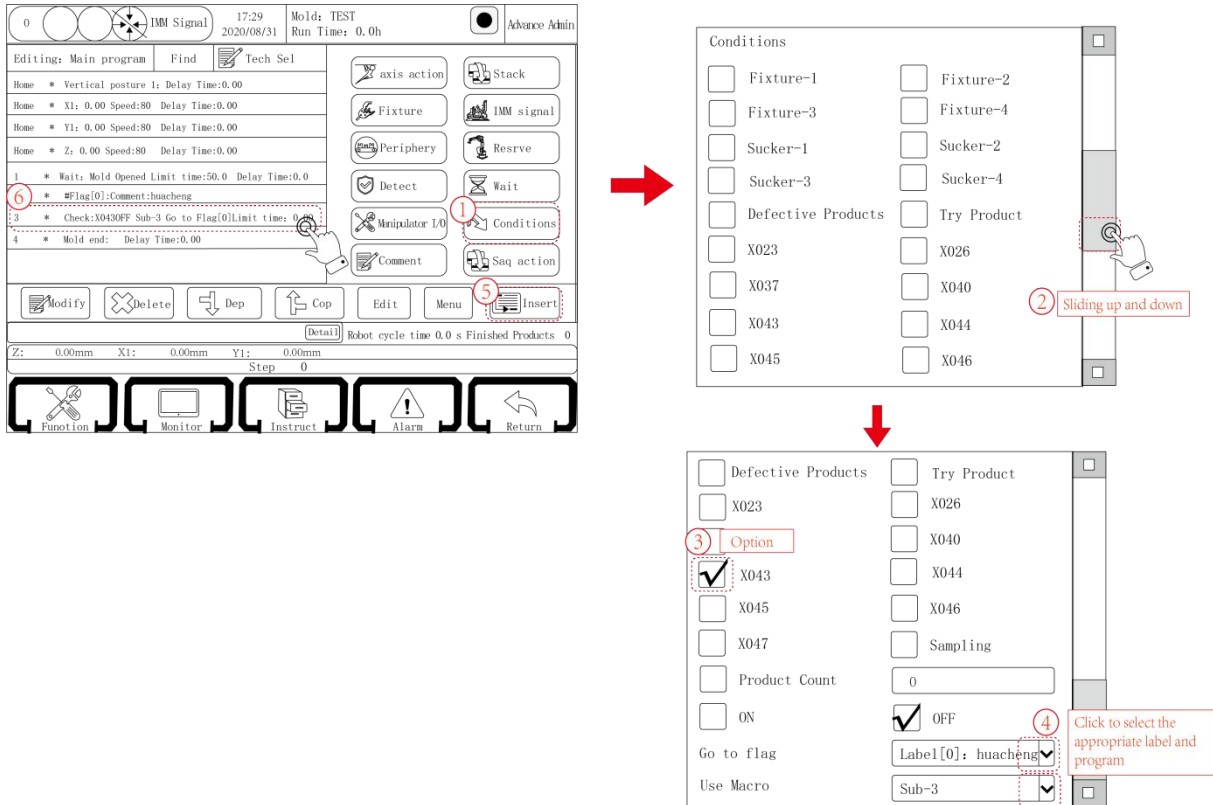

Important: Set the label annotation teaching before condition teaching, otherwise the condition can not be inserted into the main program.

- (1) The teaching of condition involves three aspects: Comment, Condition and Sub program, which are respective but indispensable.
- (2) Use: When a condition is satisfied, the system jumps into the subroutine, and after the subroutine is executed, the system jumps back to the position of the main program label.
- (3) Conditions are divided into three types: input point ON/OFF, trial production, interval modules, reject and sampling.
- (4) You must insert a label before you can insert a condition program.
- (5) Click on the instruct selection, select the subroutine to be used, click the selection button, and enter the corresponding subroutine or main program to teach, as shown in the following figure:

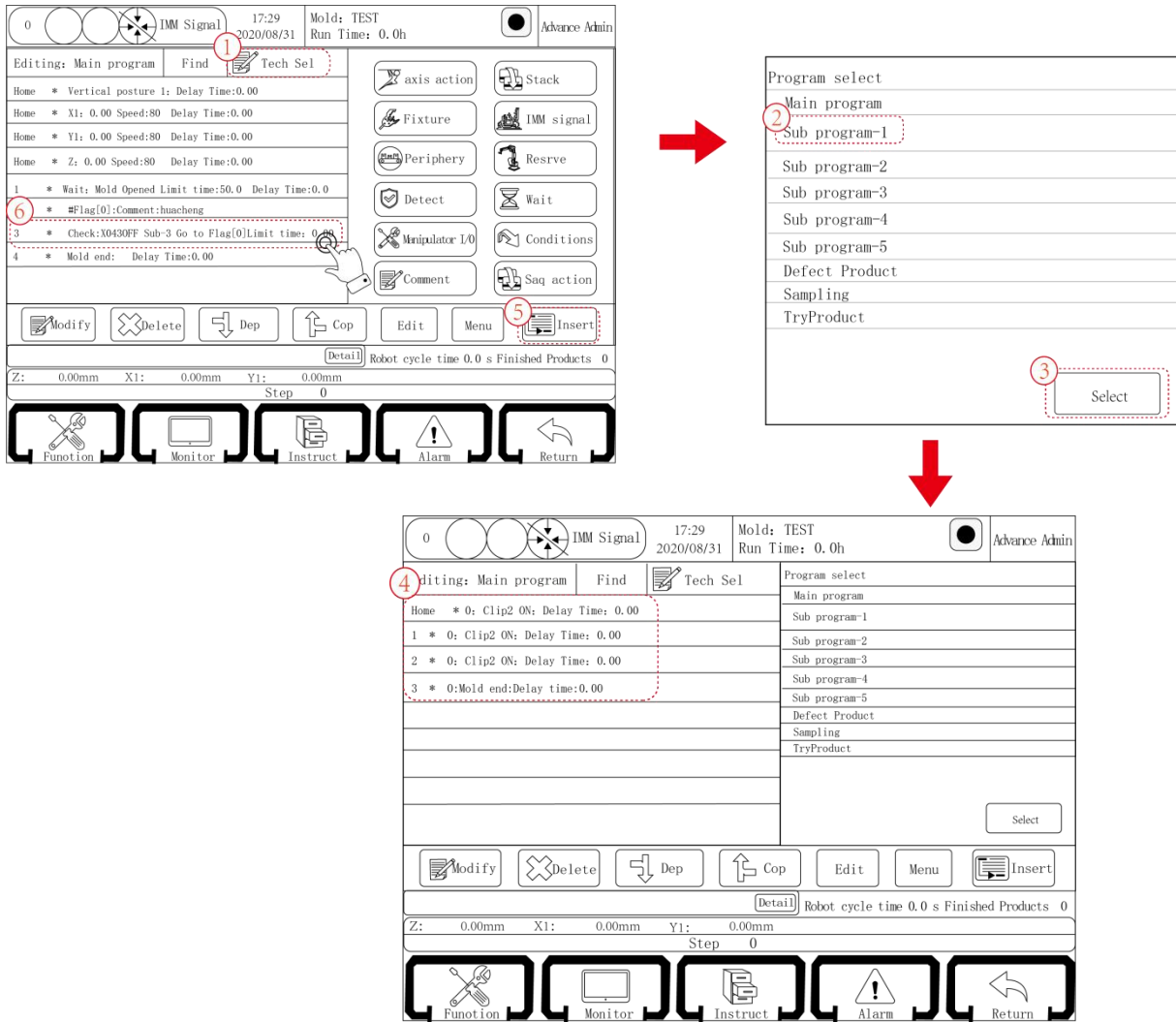

The following are examples of three types of conditions.

(1) IO input signal detection

According to the classification of conditional content, it can be divided into I/O signal class and system setting class. In the system setting classification, there are two conditions to set up in the stop state. The following is a list of categories.

Type of classification	Specific circumstances
Signal class	Fixture (1, 2, 3, 4), suction (1, 2, 3, 4), X023、X026、X037、X040、X043、X044、X045、X046、X047、bad products
System Setting Class	Interval modules, trial production(need to be set to stop status-function-product setting page), sampling (need to be set to stop status-function-product setting page)

Signal classification: As the name implies, ON-OFF of the signal is used as the judgment condition, which is more flexible than the system setting classification.

System setting classification: By setting a certain operation logic, according to the setting of regular operation. Do not detect the signal, by judging the module of the program to judge.

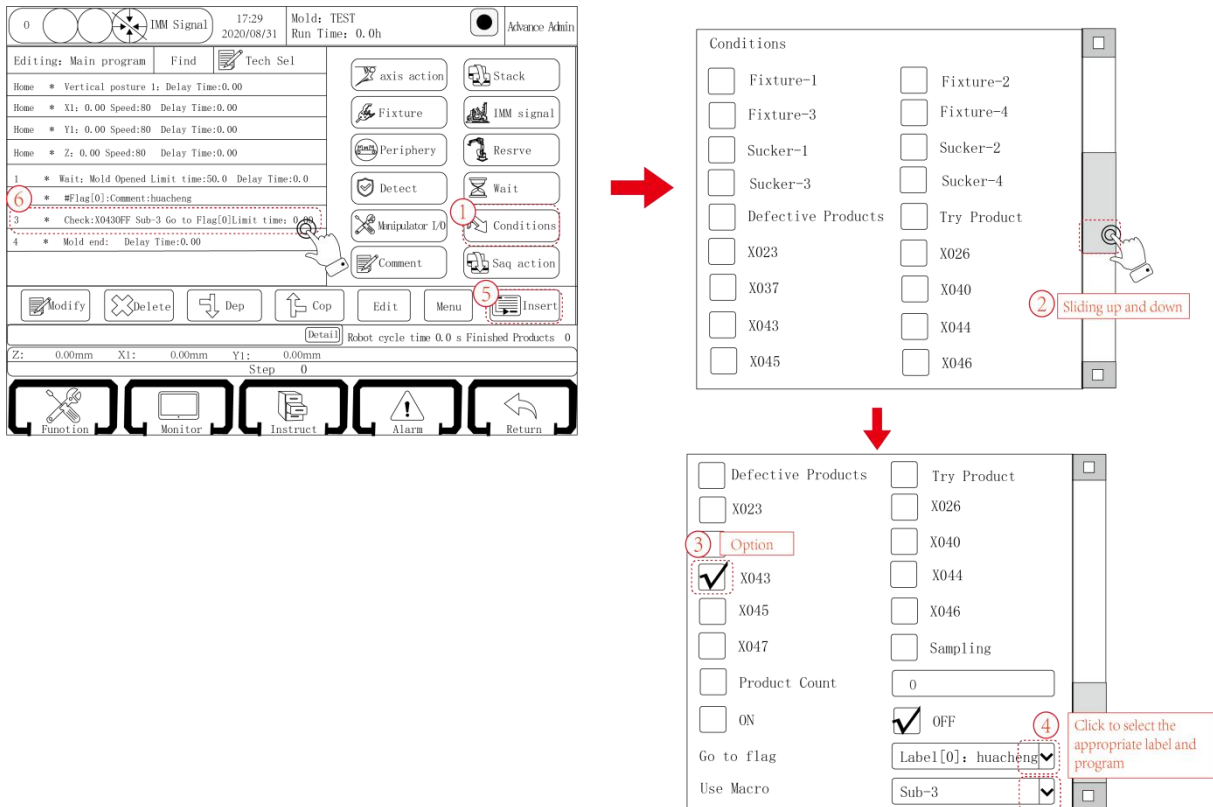

The above picture takes ON-OFF of the signal as the judgment condition, click “condition” button to enter the teaching page of the condition, select the signal “X43” and check the restriction condition “OFF” as the judgment condition, then insert the condition into the main program position.

(2) Trial Production and Sampling

Trial production and sampling are more special conditions, they can only jump to a special subroutine and only in the stop state-function-product setting page, more special, so they are classified as a class.

Trial production: Set the modulus in the stop state- Edit--Product Settings page, this module is run automatically after the end of the trial production. When running trial production, the number of finished products will be remembered, and only after the trial production will be remembered.

Sampling: A modulus is set in the stop state- Edit--Product Setting, which is sampled by a conditional jump look program at each interval.

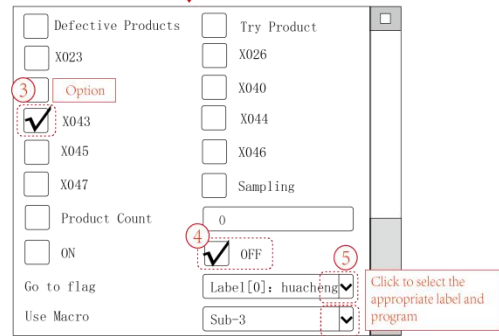
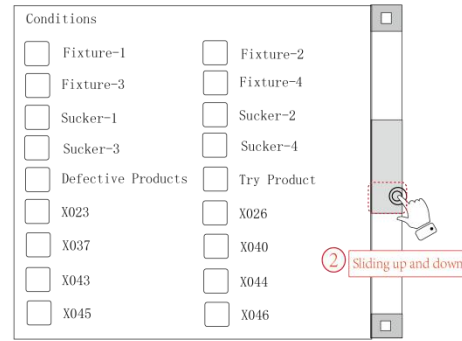
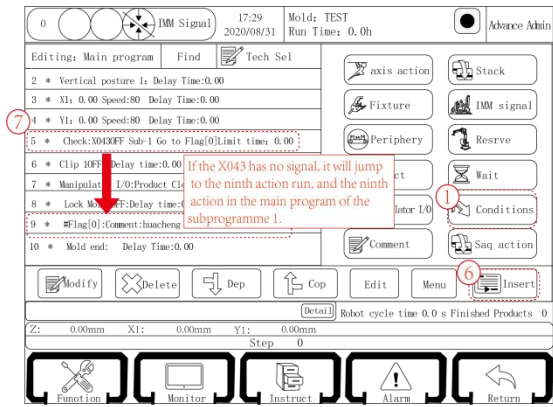

(3) Interval module

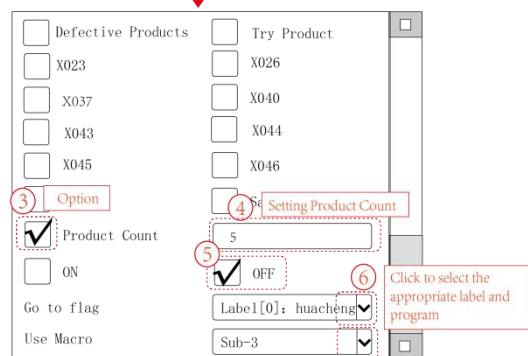
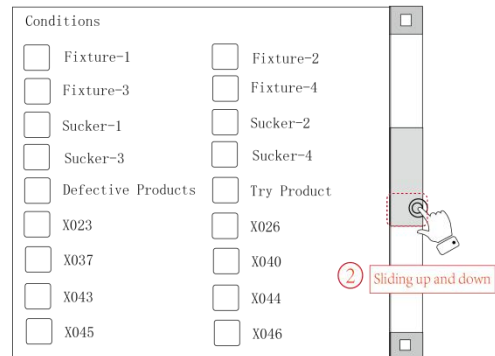
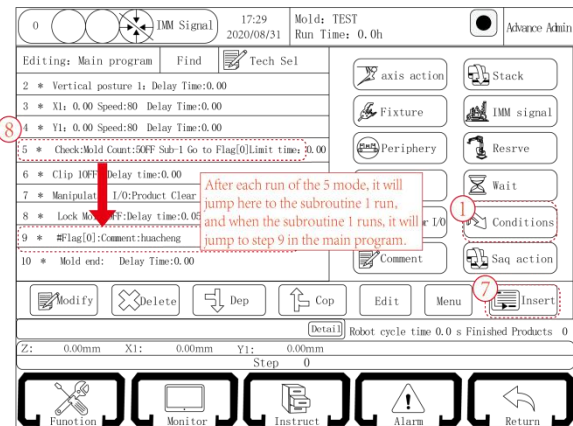

Interval modules: After the manipulator runs the N modules, the trigger condition enters the subroutine.

Tips: After the program runs to the end of the module, the number of completed products+1.

6.2.14 Teaching of Insert Program

In insert program, the step of fetching insert is before Wait mold opened. The table below shows a simple program of fetching insert.

Action taught	Description
Start * Vertical Pos1: Delay Time: 0.00	Beginning of program. Transverse Z axis is outside.
Start * X1:0.00 Speed: 80 Delay Time: 0.00	
Start * Y1:0.00 Speed: 80 Delay Time: 0.00	
Start * Z:1500.00 Speed: 80 Delay Time: 0.00	
1 * Y1:600.00 Speed: 80 Delay Time: 0.00	After the arm fetches insert outside, Z moves to 50 and standby. Wait for mold opened.
2 * Clip1 ON: Delay Time: 0.00	
3 * Y1:0.00 Speed: 80 Delay Time: 0.00	
4 * Z:50.00 Speed: 80 Delay Time: 0.00	
5 * Wait: MoldOpened Delay Time: 0.00	
6 * Y1:500.00 Speed: 80 Delay Time: 0.00	After mold opened, suck to fetch and clip signal is off, then put.
7 * X1:200.00 Speed: 80 Delay Time: 0.00	
8 * Suck1 ON: Delay Time: 0.00	
9 * Y1:600.00 Speed: 80 Delay Time: 0.00	
10 * Clip1 OFF: Delay Time: 0.00	
11 * X1:0.00 Speed: 80 Delay Time: 0.00	
12 * Y1:0.00 Speed: 80 Delay Time: 0.00	
13 * LockMold ON: Delay Time: 0.50	Spin out and descend to put. The program ends. System will return to beginning, that is to fetch inserts outside and execute next cycle.
14 * Horizontal Pos1: Delay Time: 0.00	
15 * Z:2000.00 Speed: 80 Delay Time: 0.00	
16 * Y1:800.00 Speed: 80 Delay Time: 0.00	
17 * Suck1 OFF: Delay Time: 0.00	
18 * Y1:0.00 Speed: 80 Delay Time: 0.00	
19 * Mold Over: Delay Time: 0.00	

Notice: External standby is judged automatically according to the value of Z nearest to mold opened by system. In this program, No. 4: Z50 is selected and is judged as internal standby. (If it is Wait for mold opened after beginning, choose Z at the beginning to judge standby position.)

6.2.15 Modification of Program Parameters

Click the program step to be modified, and then click the “Edit” button to pop up the following dialog box:

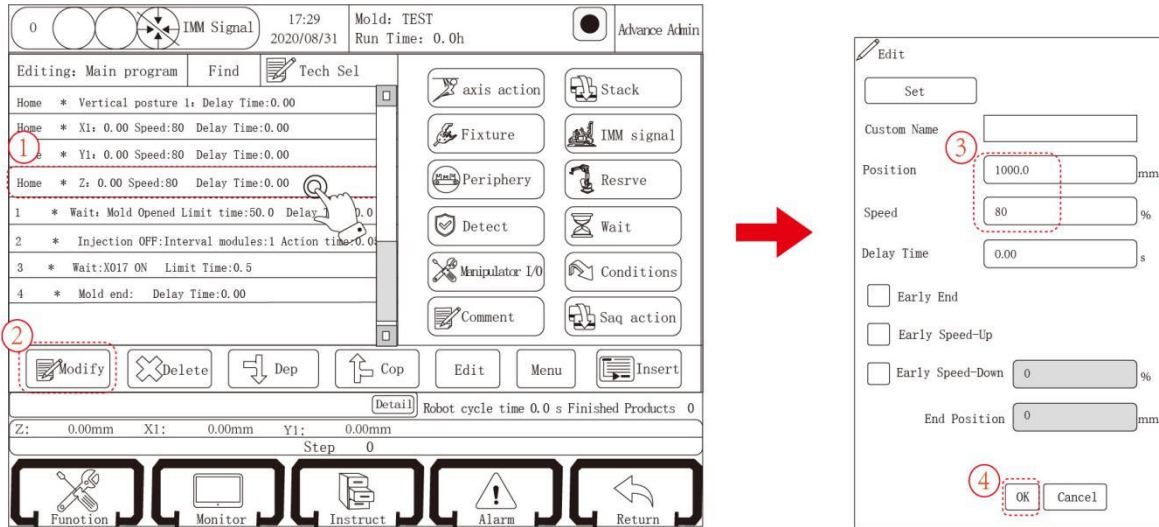

Z Axis Edit Page

On the edit page, you can modify the Position, Speed, Delay Time and Early End Position of the current action or use the Early Speed-Up, Early Speed-Down, to modify the parameters to be modified, then click “OK”.

Early end: If the early end position is set as 200, and the position is set as 1000, the axis goes to the position of 800 to jump to the next step, and this step of the program will continue to execute to 1000.

Early speed-down: If the early end position is set as 200, the deceleration speed is 5%, the position is set as 1000, and the speed is set as 80%, then the axis runs from 0-800 at 80% speed and 800-1000 at 5% speed.

Early speed-up: If the early end position is set as 200, the acceleration speed is 5%, the position is set as 1000, and the speed is set as 80%, then the axis runs from 0-200 at 5% speed and 200-1000 at 80% speed.

Reject enable:

1. When not checked, in automatic running, the Z axis moves to 1500 position and then runs to 1300 position.

2. When checked, that is to use reject enable, if the reject signal is detected, Z axis moves to 1300 mm position while running external; if not, the Z axis moves to 1500 mm position. This function is unique to the Z axis.

Note: Reject enable function can only be used outside, can not be used inside!

6.3 Examples of Teaching Program

The following teaching programs will help you understand and practice the programming of the manipulator. When teaching the manipulator program of the mould by self, please set the position of the servo shaft and control the injection molding machine according to your actual situation.

6.3.1 Requirement

The program is used to take out the injection molding product and material head. The manipulator stops above the injection molding machine mold and waits for the injection molding machine to open the mold. The starting position of the five electric shafts of the manipulator is 0, and the fixture is vertical. After the injection molding machine opens the mold, the manipulator takes out the finished product and the material head, puts the material head into the crusher, puts the finished product into the conveyor belt, and the conveyor belt moves once per mold.

6.3.2 Procedures

- Adjust the manipulator to automatic state.
- The manipulator runs to the start point and waits for the injection molding machine to open the mold.
- Fetch the finished product with Sucker 1.
- By moving the X, Y axis, the manipulator leaves the module area and outputs the mold closable signal after detecting signal of fetching finished.
- The manipulator puts the material head and the finished product on exact position respectively.
- Every time a finished product is put on the conveyor belt, it is started and runs for 3 seconds.
- The manipulator returns to the starting position standby.

6.3.3 Programming

```

Home*vertical posture 1: Delay time:0.00
Home*X1: 0.00 Speed:80 Delay time:0.00
Home*Y1: 0.00 Speed:80 Delay time:0.00
Home*Z: 0.00 Speed:80 Delay time:0.00
1*Wait: Mold Opened Limit time:50.0 Delay time:0.0
2*X1:400.00 speed:80 Early End,Early Position:150 Delay time: 0.00
3*Y1: 250.00 Speed:80 Early Speed-Down: Speed:5 Early Position:100
    Delay time;0.00
4*Wait: EUEJFON Limit time:10.0
5*Sucker1: ON: Delay time:0.00
6*Fixture1 ON: Delay time:0.00
7*Y1: 0.00 Speed:80 Early End, Early Position:250Delay time:0.00
8*X1:150.00 Speed:80 Delay time:0.00
9*Lock Mold ON: Delay time:0.50
10*Sucker1 Begin Detect Delay time:0.00
11*Fixture1 Begin Detect Delay time:0.00
12*Z:1400.00 Speed:80Delay time:0.00
13*Wait: X047ON Limit time:10.0
14*X1:534.00 Speed:80Delay time:0.00
15*Y1: 713.00 Speed:80Delay time:0.00
16*Injection ONON: Times:0 Action time:1.00
17*Horizontal posture 1: Delay time:0.00
18* Y1: 500.00 Speed:80Early End, Early Position:613, Delay time;3.00 19*
X1: 210.00 Speed:80Early Speed-Down: Speed:5Early Position:123
    Delay time;0.00
20*Fixture1 OFF: Delay time:0.00
21*Sucker1: OFF: Delay time:0.00
22*X1: 150.00 Speed:80Delay time:0.00
23*Y1: 0.00 Speed:80Delay time:0.00
24*Conveyor ON: Times:0 Action time:5.00
25*Fixture1 End Detect Delay time:0.00
26*Sucker1 End Detect Delay time:0.00
27*Z: 905.00 Speed:80Delay time:0.00
28*Mold end:Delay time:0.00

```

Chapter 7 Stop State

7.1 Program Management

Under the stop state, click the “Record” button to enter the file page, where the mold number can be New, Copy, Load and Delete.

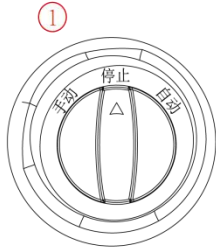

0	DM Signal	17:29 2020/08/31	Mold: TEST Run Time: 0.0h	Advance Admin
All select	All unselect	Inverse	<input checked="" type="checkbox"/> Local	<input type="checkbox"/> USB Export
		Find	Clear	
Mold Name		Create Date		New
1: KK		2020/12/07	10:57:44	Copy
2: KL		2020/12/07	10:57:44	Load
3: TEST		2020/12/07	10:57:44	Delete
Existing modules				Export
				EX Print
				Import
Original File Name	New File Name			
		(Detail)	Robot cycle time 0.0 s	Finished Products 0
Z:	0.00mm	X1:	0.00mm	Y1: 0.00mm
Step 0				
Function	Monitor	Record	Alarm	Return

New: Enter the name of the new mold number in the “new file name” text box, then click the “New” button to create a new blank mold number program. Letters and numbers can be used in file names.

Copy: After entering the new name in the “new file name” text box, click the stored mold number name, and then click the “Copy” button to copy the stored mold number program into the new mold number file.

Load: Click the existing mold number program and click “load” to load selected program. Current mold number will be changed to the name of loaded program after loading completed.

Delete: Click the stored mold number program, and then click the “Delete” button to delete the mold number.

Note: The mold number being in use can not be deleted.

Export: After inserting the USB, check the “USB Export” box. Click the stored module program, and then click the “Export” button to export the selected program to USB flash drive.

Import: After inserting the USB, check “USB import” to see the program in the USB. Check the program to be imported and click “Import” then you can import the program from the USB flash drive to the manual controller. If the import is successful, the imported mold number will appear in “Local Mold Number”.

Search: Enter the required mold number name in the box, click search to find required mold number.

Clear: Clear the search records.

7.2 Function

Click the “Function” button in the lower left corner of the screen to enter the function setting page. As shown below:

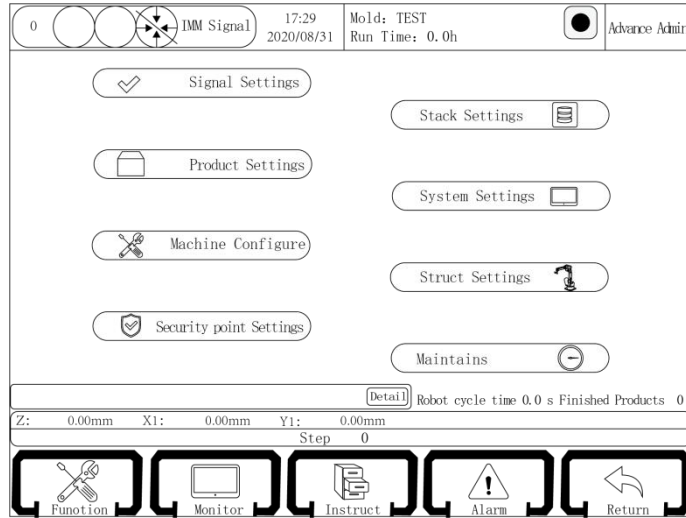

The function settings page contains eight sub pages including “Signal Settings”, “Product Settings”, “Machine Configure”, “Security Point Settings”, “Stack Settings”, “System Settings”, “Struct Settings” and “Maintenance”.

7.2.1 Signal Settings

Click the “Signal Settings” button on the screen to enter the signal detection settings page, where you can set whether to detect certain input signals or not.

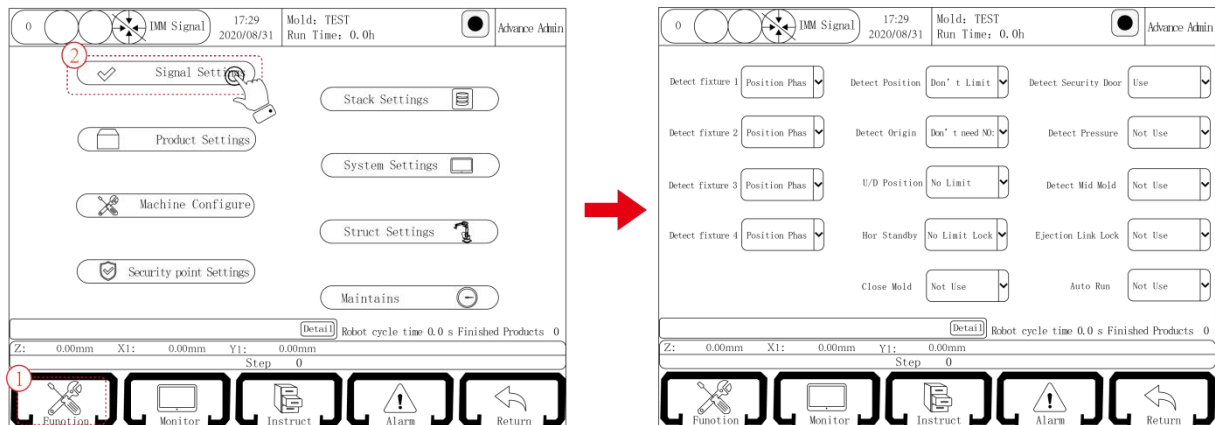

(1) Fixture 1, 2, 3, 4 detection

Positive phase: The corresponding fixture switch positive phase detection, when the corresponding fixture confirms the limited signal input, it represents the fixture has taken the object successfully; when the corresponding fixture confirms no limit signal input, it represents the fixture has failed to take the object.

Negative phase: The corresponding fixture switch negative phase detection, when the corresponding fixture confirms no limit signal input, it represents the fixture has taken the object successfully; when the corresponding fixture confirms the limit signal input, it represents the fixture has failed to take the object.

Important: No matter the positive or negative phase is selected, the detection can not have signal input when the fixture has no action.

(2) Transverse posture

Horizontal: When manipulator crossing in/out manually, the fixture must be in a horizontal state. When teaching automatic program, transverse posture must be horizontal.

Vertical: When manipulator crossing in/out manually, the fixture must be in a vertical state. When teaching automatic program, transverse posture must be vertical.

No limit: When manipulator crossing in/out manually, there is no limit to fixture state. When teaching automatic program, transverse posture can be taught as needed.

(3) Origin reset

Not need mold opened signal: When the origin is reset, no matter whether there is a mold opened signal, the origin reset action can be carried out.

Need mold opened signal: When the origin is reset, it needs mold opened signal to execute origin reset.

(4) Up/Down posture

Horizontal: To start origin rest, the fixture must be horizontal when the arm moves up and down.

Vertical: To start origin rest, the fixture must be vertical when the arm moves up and down.

No limit: There is no limit to the posture of fixture.

(5) Horizontal standby

Limit lock mold: In horizontal standby, arm should rise and be horizontal before locking.

Not limit lock mold: In horizontal standby, once the arm rises, the mold is locked.

(6) Mold lock

Use: There is a “Mold closed” signal after the “Mold Opened” signal, the manipulator will descend to fetch, otherwise it will alarm that mold lock is not in place.

Not use: Do not detect the “Mold closed” signal.

(7) Safety door detection

Use: When the manipulator runs automatically, the safety door signal is detected all the time. If there is nor signal, alarm immediately.

Not use: When the manipulator runs automatically, the safety door signal is detected only when the arm descends inside. If there is no safety door signal, alarm immediately.

Note: when checking “Not use” , as the manipulator descending inside, the system must detect the safety door signal, too. This is a safety mandatory measure.

(8) Pressure detection

Use: The manipulator detects the gas pressure. If the pressure does not reach the set value, it will alarm.

Not use: The manipulator does not detect the gas pressure. No matter whether the air pressure reaches the set value or not, it will not alarm.

(9) Mid-mold board

Use: The manipulator detects the signal of the mid-mold board, and it will alarm if no signal is detected while the arm is descending inside. Please select “Use” if the mold is three-board.

Not use: The manipulator does not detect the signal of the mid-mold board.

(10) Thimble link lock

Not use: Allow the thimble signal to be output all the time.

Use: After the mold is in place, the thimble signal will be off. When the program teaches the thimble step, the thimble will be output.

(11) Fully automatic

Not use: The manipulator does not detect the automatic signal of the injection molding machine.

Use: The manipulator detects the automatic signal of the injection molding machine, and if there is no automatic signal in automatic state, the alarm will be sent.

7.2.2 Product Settings

Click the “Product Settings” button on the function settings page to enter the product settings page. As shown below:

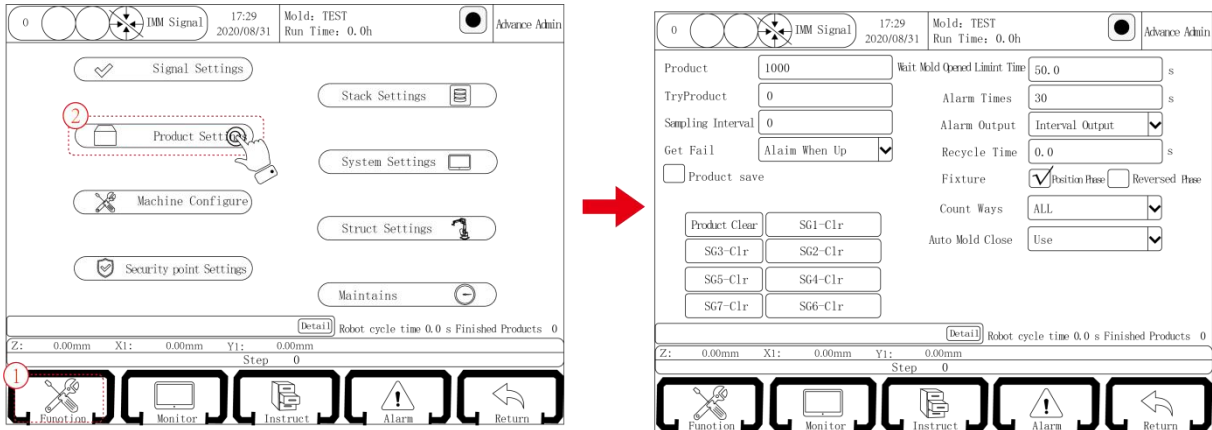

Product: The number of products planned to be produced. When the actual production is up to this value, alarm will be sent; if the value is set as 0, it will not alarm.

Trial product module: Set the number of products for trial production.

Sampling interval: Set the interval modulus for product sampling.

Wait mold opened limit time: The manipulator waits for the opening signal time, no opening signal in the set time, then alarm.

Fetch fail:

Internal up alarm: After detecting the failure, send an alarm when the arm rises inside.

Real time alarm: Send an alarm the moment detecting the failure.

Alarm time: When an alarm occurs, the time when the warning device makes a sound.

Alarm output:

Interval output: When alarm occurs, the alarm lamp flashes.

Long output: When the alarm occurs, the alarm lamp is always output.

Cycle time: When selecting the lock mode in place function, time taken from when the system receives the mode-locked signal (that is, the mold closed signal) to when the mold closable signal is off.

Fixture:

Positive: The fixture is the posture of the moving die product.

Negative: The fixture is the position of the mould product, and the horizontal and vertical of the fixture will automatically reverse.

Product clear: Click this button to zero the number of finished products.

Conveyor counter: Conveyor counter must be selected as all.

Product save: The current output can be remembered after power failure.

Stack clear: Click the button to zero the number of stacks that the stack group completes.

Auto Mold Close:

Use: After the third switch hits the automatic state, the die can be output immediately.

Not use: After the third shift switch hits the automatic state, the switch mode will not output automatically. When the switch automatically runs to the lock mode action, the switch mode can only start the output.

7.2.3 Machine Configure

Click the “Machine Configure” button on the function setting page to enter the run parameter setting page. As shown below:

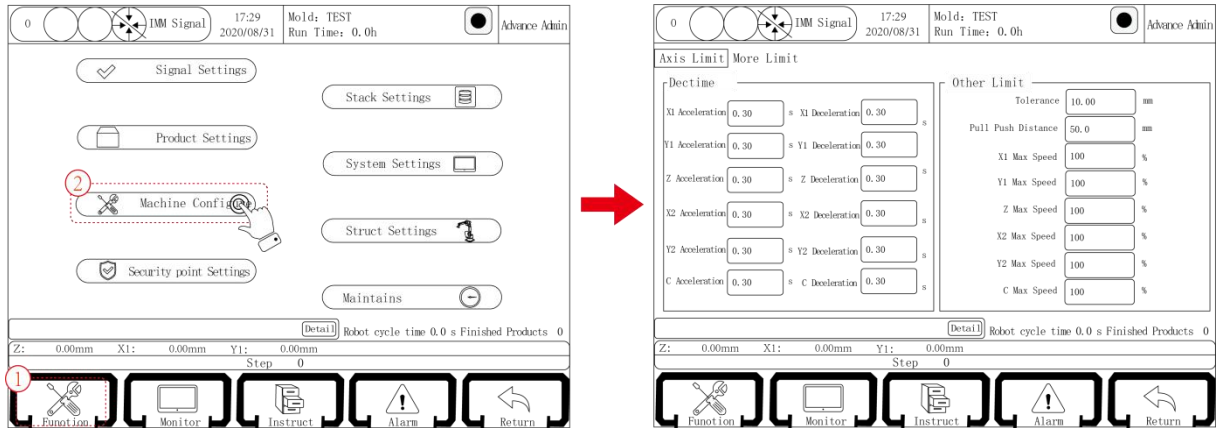

Tolerance: The difference between the distance from the instruction run and the distance from the actual run feedback. **(This parameter does not affect system positioning accuracy)**

Crosswise space: If the X1X2 are servo shafts, set the safe distance between the main arm and the auxiliary arm.

Internal acceleration/deceleration time: Set the acceleration / deceleration time of servo motor in type.

External acceleration/deceleration time: Set the acceleration and deceleration time of servo motor outside the type.

Manual acceleration/deceleration time: Set the acceleration and deceleration time of servo motor in manual state.

Speed limit: Set the maximum operating speed of the servo motor in %.

7.2.4 The Relationship between Several Speeds

At full automatic operation, the speed depends on the **overall speed** of the red circle and the **step speed** of the green circle. (all in percentage)

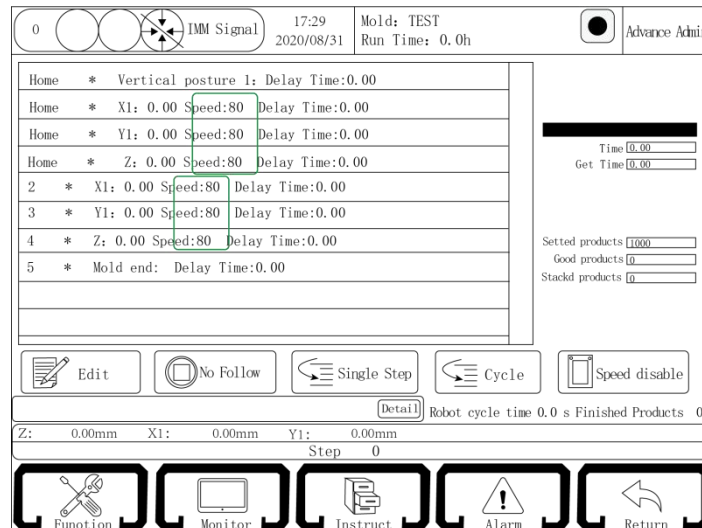

1. Real Speed = Overall Speed × Step Speed

(1) If the actual operating speed is 100 %, the pulse is 500 . The general corresponding servo speed is 3000 rpm.

(2) Assuming a overall speed of 80 and a step speed of 80, if the actual running speed is 64 %, that is, the corresponding pulse is 320 KHz, the corresponding speed is 1920 rpm.

(3) In Function-Running parameters, you can adjust the maximum speed of each axis. **(The actual speed can not exceed the maximum speed)**

Supposed that the maximum speed of the X axis is set as 50, the overall speed is 80 and the X axis step speed is 80.

The actual running speed of the X axis is 64 % and this value is greater than the maximum speed, then the X axis still runs at the highest speed 50 and the corresponding pulse is 250 KHz, corresponding rotational speed is 1500 rpm.

7.2.5 Structure Settings and Security Point Settings

In Structure Settings and Security Point Settings pages the parameters of the axis are set uniformly, except for the restricted pages set by the security point, the same pages will no longer be introduced further.

(1) X1, X2 axis parameter page and security point setting limit page

Click the “Struct Settings” button on the function setting page to enter the machine parameter setting page, where you can set the parameters of each axis. After entering the page, go directly to the X axis parameter settings, as shown below:

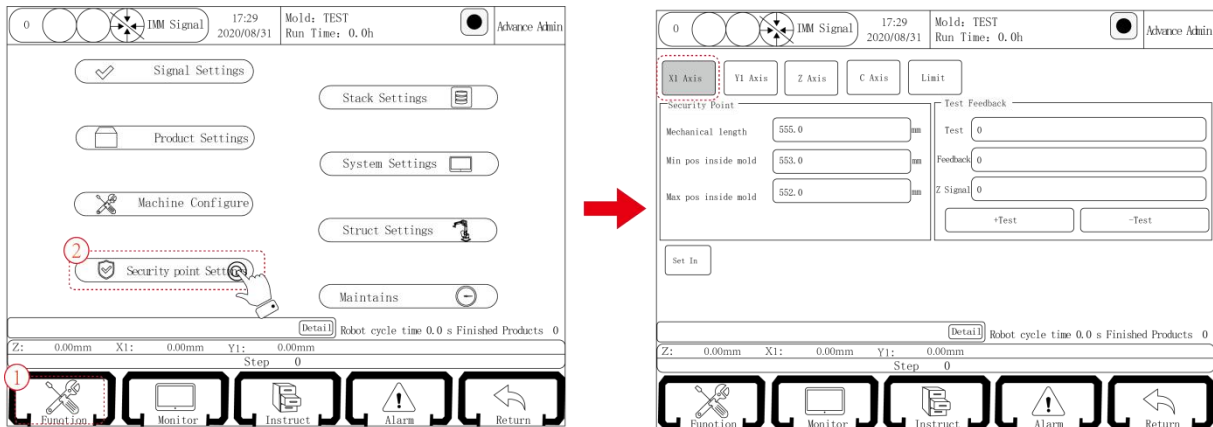

Motor reverse: When motor rotates anticlockwise by default, the axis moves away from the origin; if checking motor reverse, the motor rotates anticlockwise and to the origin.

Mechanical length: Set the maximum distance of X axis movement.

Origin offset: (This feature should check the origin bias in the structure-origin definition, otherwise the value can not be set)

If the bias is positive, continue to move a certain value away from the origin after returning to the origin.

If it is negative, continue to move a certain value to the origin after returning to the origin.

Assuming that the rotation distance is 20 and the bias value is 40, the motor continues to take two turns to the origin after returning to the origin.

Note: After the offset is completed, the coordinates are still shown as 0.

Min pos inside mold: When the Y axis descends into the mold, the minimum position of the X axis can be moved.

Max pos inside mold: When the Y axis descends into the mold, the maximum position of the X axis can be moved.

+Test: Carry out positive rotation test of motor. Normally, test and feedback show 10000.

-Test: Carry out motor reversal test. Normally, test shows 10000 and feedback shows -10000.

Tip: If the feedback is not correct, modify the parameters of the servo feedback pulse direction.

Important: The moving position of the X axis also depends on the parameters in the limit. If the maximum movement of the X axis is adjusted, the limit also needs to be adjusted, otherwise the maximum movement can not be reached.

Distance per rotation: Set the distance of each servo shaft motor running in one turn. Click on the positive rotation of the motor to measure the distance from the actual operation of the corresponding shaft, which is the distance from which the shaft motor rotates in a circle.

Warn: If set incorrect, it may cause machine malfunction.

Note: The parameters of the X2 and X1 axis are the same.

Motor forward and reverse rotation is an important measure to test motor direction, that is, to confirm the direction of origin. It is the first step of debugging the machine. The reverse direction of all axes is the direction of origin.

Limit page:

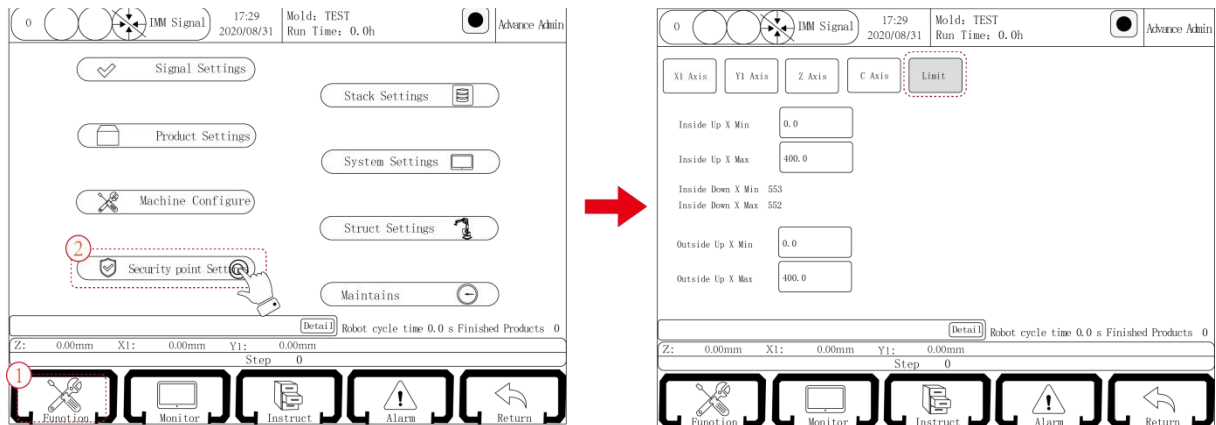

X axis Min position when up internal: A minimum position allowed of the X1 axis when the arm rises inside mold.

X axis Max position when up internal: A maximum position allowed of the X1 axis when the arm rises inside mold.

X axis Min position when up external: A minimum position allowed of the X1 axis when the arm rises outside mold.

X axis Max position when up external: A maximum position allowed of the X1 axis when the arm rises outside mold.

Note: The minimum and maximum position of X1 axis descending inside the mold are modified in the mechanical parameter page or the safety point setting page X1 axis.

The X1 and X2 axes are at both ends of the drawing beam by default, so their mechanical length is the same as the maximum displacement. In order to prevent the collision between the two axes, the drawing distance X1 the maximum displacement of the current coordinate value of the axis X2 the current coordinate value of the axis, that is:

If the length of the beam is 400, the maximum movement of the X1, X2 is 400. When the current position of the X1 is 200, the maximum X2 can only reach 150 200 150 50 (drawing distance)=400

(1) Y axis parameter page, as shown below :

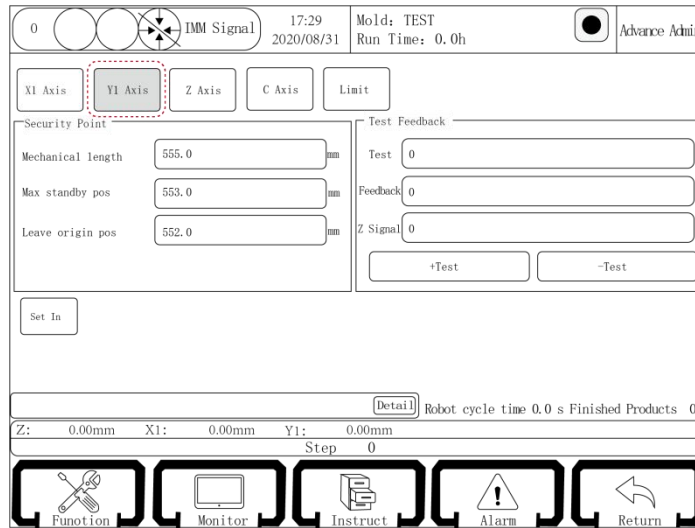

Max standby pos: Set Y1 axis maximum standby position point.

Leave origin pos: Position where the Y1 axis descends and leave origin point. If set as 400, when the Y1 axis descends more than 400 and the Y1 origin switch still has a signal, the system will send alarm.

Tip: This parameter is to ensure that the Y shaft motor is moving (that is, the structure is normal) because the switch has a certain delay. Please set this parameter large (larger than the length of the origin iron sheet).

+Test: Carry out positive rotation test of motor. Test and feedback both show 10000.

-Test: Carry out motor reverse test. The test shows 10000 and the feedback shows -10000.

(3) Z axis parameter page, as shown below :

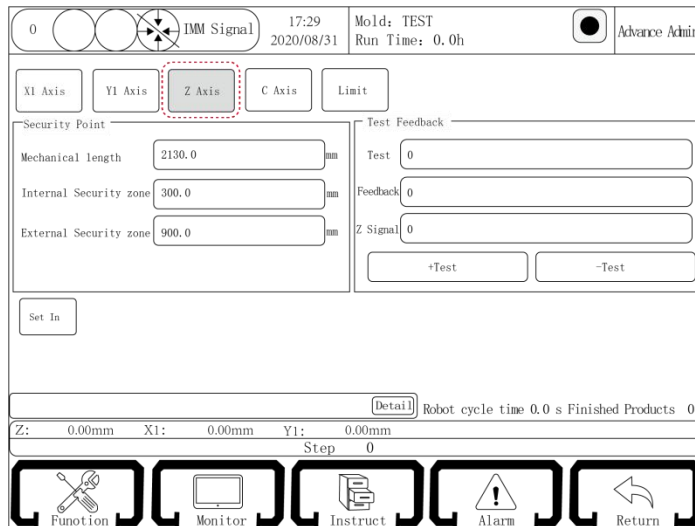

Internal safety zone: Set the location of the internal fetching safety zone.

External safety zone: Set the location of the external placement safety zone.

(4) C axis parameter page, as shown below :

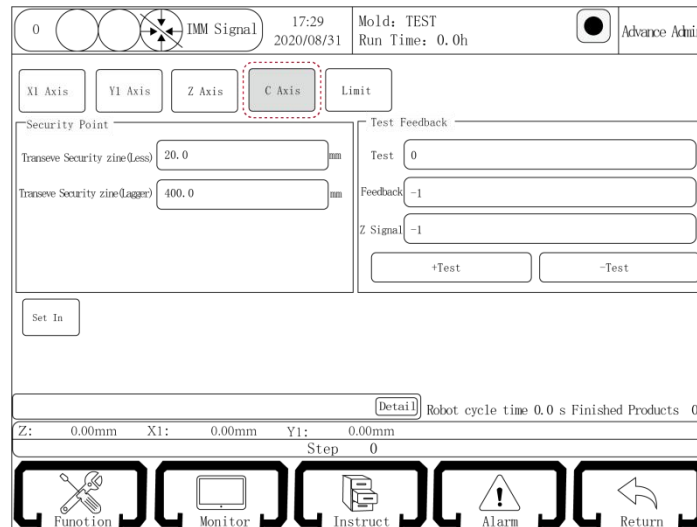

Max Rotation: A maximum range of C axis rotation is 360 degrees.

Origin offset: The range is (-90,+90).

If the value is positive, keep moving toward the origin for a distance.

If the value is negative, move back to the max displacement for a distance.

Note: The coordinate is still zero after completing offset.

Transverse safe range: Limit the safety angle of the fixture during horizontal action.

As shown above, (0-20;300-360) is the safety range of the C axis, that is the horizontal state.

Notice: This parameter is valid only when the C is a servo shaft. This parameter is invalid when the C is a pneumatic shaft.

After the C axis returns to the original point, it is in a vertical state.

(5) Axis Definition page for “Structure”

(no servo parameter adjustment screen for single-board)

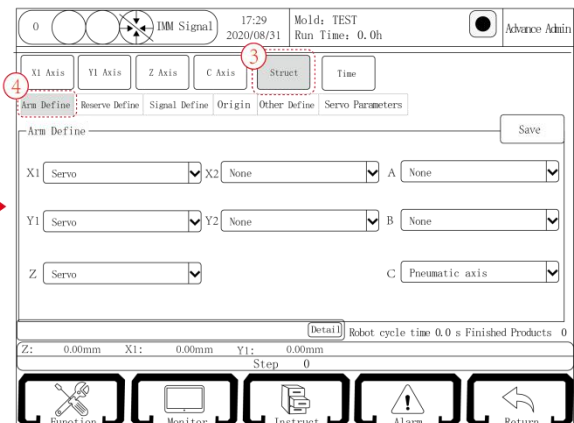
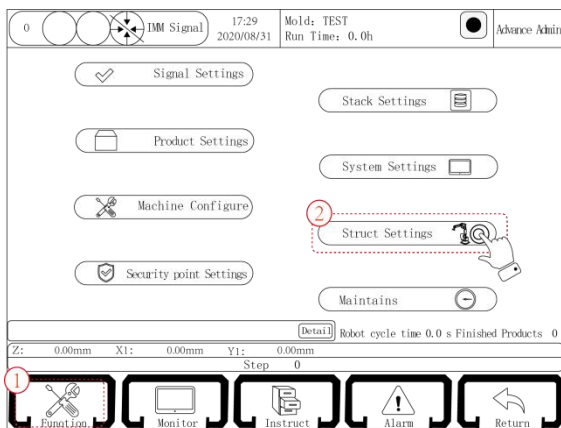

Struct: It is divided into “Arm Define”, “Reserve Define”, “Limit Define”, “Origin”, “Other Define” and “Servo tuning”.

Axis define: Each axis can be set to be pneumatic/servo/step/none. Each should be selected as servo shaft or pneumatic shaft according to machine condition.

Tips:

1. This system is 3-axis system by default, that is, X1、X2、Y1、Y2 and Z axes should be selected as servo axis, otherwise, it may cause system faulty.
2. If the machine is bilateral, the A shaft should be selected as pneumatic shaft.

(6) Structure's Reserve Define page:

Please check “Reserve” for all the options because this product no longer uses position adjustment function.

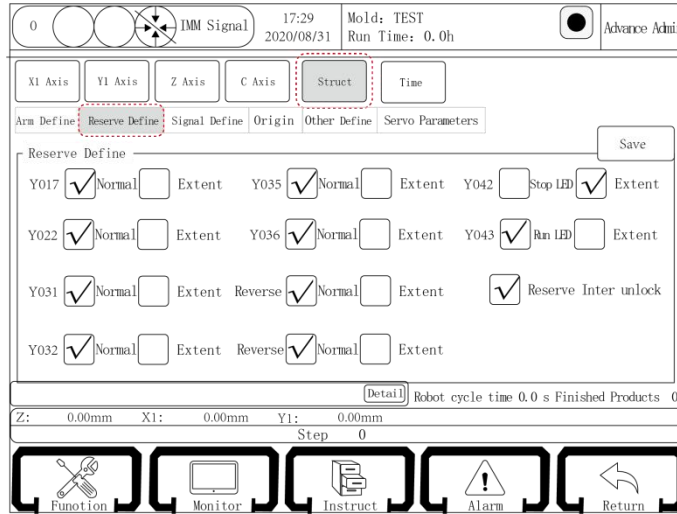

Y042: Check Stop lamp. Monitor output page displays as stop lamp, Reserve checked displays as Reserve 9.

Y043: Check the running lamp. Monitor output page displays as running lamp. Reserve checked displays as Reserve 10.

Reserve 1 Reserve 2 Not interlocked :

Check: Reserve 1 and Reserve 2 outputs do not affect each other.

Unchecked: Reserve 1 and Reserve 2 interlocking, that is, if Reserve 1 has output, Reserve 1 output signal will be off when Reserve 2 has output; if Reserve 2 has output, Reserve 2 output signal will be off when Reserve 1 has output. These two signals cannot output at the same time.

(7) Structure's Limit Define page:

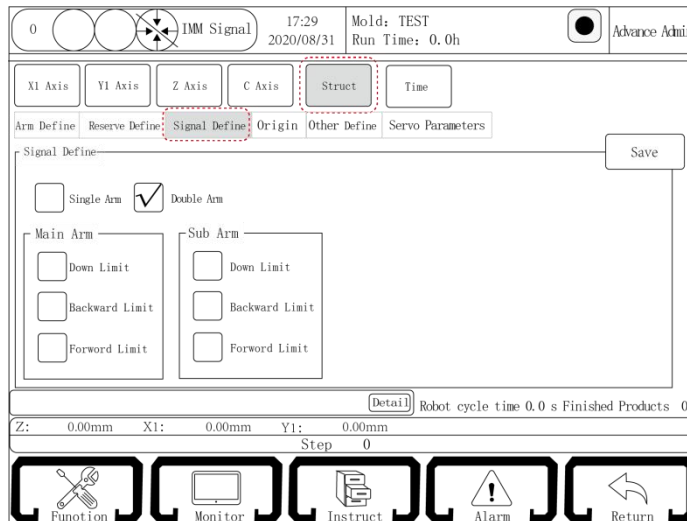

Limit definition is divided into single/double arm selection and limit switch signal selection.

Single Arm: In the manual state, only teach main arm action, and the buttons “X2+” , “X2- ” , “Y2+” , “Y2- ” are invalid.

Double Arms: In the manual state, the main arm and the sub arm actions can be taught, and the sub arm key is valid.

Main arm: Descending limit, backward limit, forward limit.

Sub arm: Descending limit, backward limit, forward limit. If the sub arm is an pneumatic shaft, the limit is effective. When the corresponding pneumatic shaft is operated, the limit signal must be given before the program can perform the next step, otherwise the alarm will be sent.

Note: Limit definition is valid only for pneumatic axis and invalid for servo axis.

(8) Structure's Origin page:

Abs Servo: (useless for single-board)

Check: Absolute value way back to origin.

Not checked(as the picture above): Incremental way back to origin.

After modifying the return origin mode and saving, it needs to exit the current page that the new return origin mode can work.

Origin Sequence Enable: Check the origin sequence enable and save. Return to origin in incremental way as axis order that is set. Set 1 as X1, 2 as Y1, 3 as Z and 4/5/6/7/8 as none to return in X1-Y1-Z. If set 1 as none, 2 as X1, 3 as none, 4 as Y1, 5 as none and 6/7/8 as none or other axis, it is unable to return.

Origin Offset: Check "Save", the origin offset function is effective. If not, the function will not work. (Origin offset dialog in each axis page is executable and can be modified if checking "Save". If not, values cannot be entered into the dialog.)

Z Outside Origin:

Not checked: X25 is the back to origin signal, after returning to the origin, the starting position is in the type.

Check: X24 is the back to origin signal, after returning to the origin, the starting position is out of type.

Long Origin: If checked, way back to the origin is that the long origin returns.

Short origin: If checked, way back to the origin is that the short origin returns.

Limit Origin: If checked, way back to the origin is that the limit signal returns.

(9) Structure Other Definitions Page:

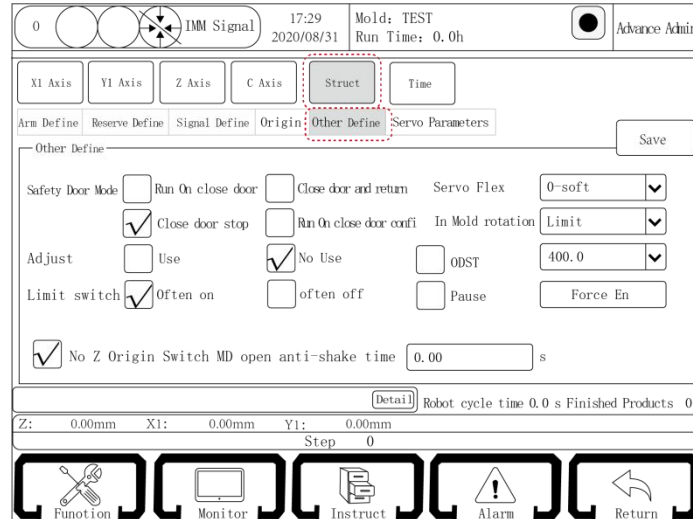

After modifying the parameters, click the save button so that the parameters remain unchanged after power-down restart.

Safety Door Mode:

Run On close door: After the manipulator failed to fetch, the safety door is opened and then closed. The manipulator continues to perform the program of this mold.

Close door and return: After the manipulator failed to fetch, the safety door is opened and then closed. The manipulator executes the program before mold opened again. After moving to the start point, wait for the next mold opened signal..

Close door stop: After the manipulator failed to fetch, the safety door is opened and then closed. The manipulator stops in the current position and exits automatic state.

Run On close door confirm: After the manipulator failed to fetch, the safety door is opened and then closed. Click “Continue” in the dialog popped up, then the robot continues executing program of this mold. Click “Give up”, then the manipulator returns to the origin and fetches again.

Adjust: Choose to use or not to use the electric position adjustment function. (Existing models are generally not in use)

Limit switch:

Often on: The limit switch is on by default. When the limit switch has a signal, the limit switch is disconnected; if beyond the limit position, the limit switch has signal input and it will alarm immediately; if limit switch has no signal input, there will be no alarm.

Often off: The limit switch is off by default. When the limit switch has a signal, the limit switch is turned on; if beyond the limit position, the limit switch has signal input, there will be no alarm; if the switch has no signal input, it will alarm immediately.

In Mold rotation:

Limit: Limit the internal descending posture as vertical and side posture is forbidden.

No Limit: No limit for internal descending posture and side posture is allowed.

ODST: After checking, the external descending safety signal is on, and it will alarm when it is over the safety time; if not checked, this function is invalid.

Servo Flex: To improve the curve of motion planning. (Optional, not available for standard)

Force En: When the servo enable is abnormal, it is recommended.

No Z Origin Switch:

Not check: It needs X25 signal to descend in the internal safety area.

Check: No need for X25 to descend in the internal safety area. It is only taken as the origin signal.

MD open anti-shake time: If the signal stability is poor, set a larger value.

7.2.6 Servo Parameters

Go to the Struct Settings – Struct – Servo Parameters page and set the servo parameters.

In box 1, to check the servo parameters of the exact axis, click the refresh button, the servo parameter value will be displayed in the corresponding box. If you need to modify the parameter value, you can enter a new value directly in the text box. Servo parameters can also be set in box 2 on the right.

Servo Addr: Set the servo parameter number in box 3 ; the current servo parameter value is displayed in box 4.

Value: Box 5 is the servo parameter target value that needs to be set.

Parm Name: The function corresponding to the current servo parameter number

Setting Steps:

1. Press the emergency stop button. (Modify the servo parameters in this state)
2. Enter the servo parameter number in orange box 3.
3. Enter the servo parameter target value in the green text box 5 after “parameter value” and click “Send” .
4. Check whether the values in box 4 are the same as the target parameter value. If it is, the parameters are set successfully; otherwise it needs to be reset.
5. After the parameter setting is successful, restart the servo and manual controller, the new parameters will work.

7.2.7 Servo Parameter Table

Function Code	Mapping Address	Function Code Name	Parameter description	Scope	Unit	Default
PnE00	0x2E00	Software Version/ Reactivation	Write 8051 to restore factory settings	0~65535		version number
PnE01	0x2E01	Driver Type	2:100~200w; 3:400w; 4:750w; 5:850~1300w 6:1800w	2~6		4
PnE02	0x2E02	Motor code		1000~ 1600		1400
PnE03	0x2E03	Parameter management	Write 256 to restore factory settings (11xx series) 1: Senior mode. Jam param check. Able to clear overload. Encoder error alarm	0x0000~ 0x1111		0x0000
PnE04	0x2E04	Mandatory motor code	1: mandatory			
PnE15	0x2E0F	Motor overload protection factor	10~100	10~100		50
PnE19	0x2E13	Single/Double Axis Selection	0: biaxial , 1: uniaxial			
PnE21	0x2E15	Velocity loop gain	Larger value means faster response. May cause shock if too large. Synergistic adjustment of position mode with position loop gain	0~500	Hz	90
PnE22	0x2E16	Velocity loop integral time constant	Smaller value means stronger integral ability and stronger speed tracking ability Need to match velocity loop gain and position loop gain	0~300	ms	25
PnE23	0x2E17	Position loop gain	Larger value means faster response. May cause shock if too large. Synergistic adjustment of position mode with position loop gain	0~20	1/s	4

PnE28	0x2E18	Speed feedforward gain	Increase to reduce reduce the steady-state position deviation, and the overshoot is caused by excessive assembly	0~100		0
PnE30	0x2E1E	Camping coefficient	Position loop damping coefficient	100~500		100
PnE31	0x2E1F	Speed feedback low pass coefficient		100~20000		20000
PnE32	0x2E20	Current feedback low pass coefficient	Detect actual current direction	100~2000		20000
PnE33	0x2E21	Torque feedforward coefficient		0~100		0
PnE34	0x2E22	Velocity loop differential gain (low frequency)		0~1000		0
PnE41	0x2E29	Moving average filter constant	0~200.0	0~200.0	ms	0
PnE42	0x2E2A	First-order low-pass filter constants	0~6000.0	0~6000.0	ms	0
PnE49	0x2E31	Position Deviation Limit	0.1~50.0 laps	0.1~50.0		5.0
PnE69	0x2E45	Torque instruction low pass coefficient		100~20000		20000
PnE71	0x2E47	Action Command	1: the current position set as zero	0~255		0
PnE72	0x2E48	Frequency of notch filter		0~10000		0
PnE73	0x2E49	Frequency width of notch filter		0~1000		0
PnE99	0x2E63	version number	version number	0x0000~0xFFFF		0x0000

7.2.8 Machine Time

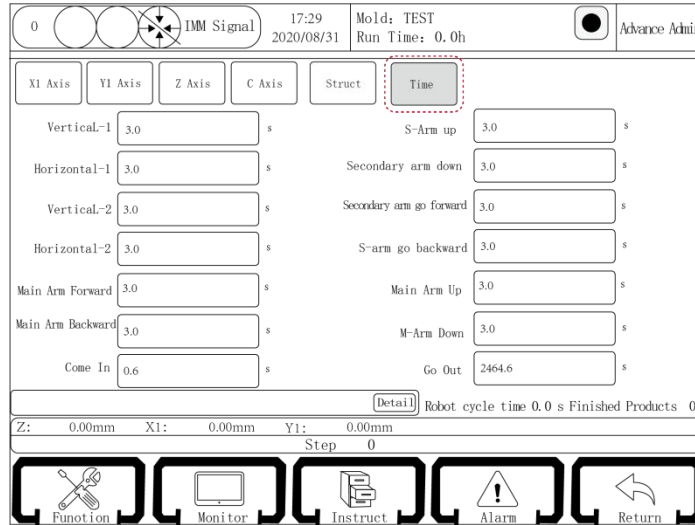

Under this page, the limit time of each axis action can be set, and the time of each axis action exceeds this set value and there is no corresponding input signal to alarm. (only valid for pneumatic shaft)

7.2.9 Stack Settings

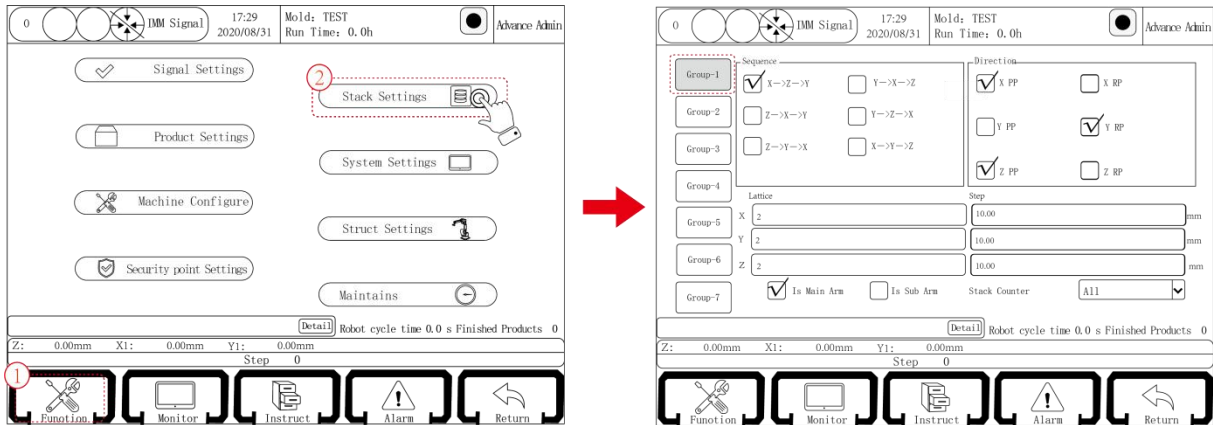

The product stacking function of the manipulator can arrange the finished products neatly on the conveyor belt or loading box in some way. The system is equipped with 7 groups of stacking, the first 6 groups are regular stacking, and the seventh group is free stacking.

Regular stack: Click on the stack group to be used (such as group 1), select the order in which the product is stacked in the sequence bar, and set the number of stacked products per axis and the stacking spacing of the product.

Lattice: The number of products to be stacked in a certain axis direction.

Space: In a certain axis, the distance between two adjacent objects.

Sequence: In the order in which several axes are stacked upward.

Four types of stacking order are defined the same, taking X-Z-Y order as an example, the rest are not described.

X-Z-Y: The stacking program first arranges the product on the X axis, then arranges the Z axis, and finally stacks the Y axis.

Direction:

PP: That is, the stacking position is getting larger and larger.

RP: That is, the stacking position is getting smaller and smaller.

- Sub arm stack:** (1) The program defaults to the main arm stack, that is, only the main arm stack, the secondary arm does not stack.
 (2) The X1、Y1 and X2、Y2 are stacked at the same time. The stacking sequence, direction, number and spacing are the same.

Stack counter: In this system, there are 9 methods in this system. For each group of stacking, there are 3 options, such as stacking 1 group, stacking counter can choose all, good products and stacking 1 group. If you choose another stacking counter, the program may be abnormal.

Examples of stack program settings:

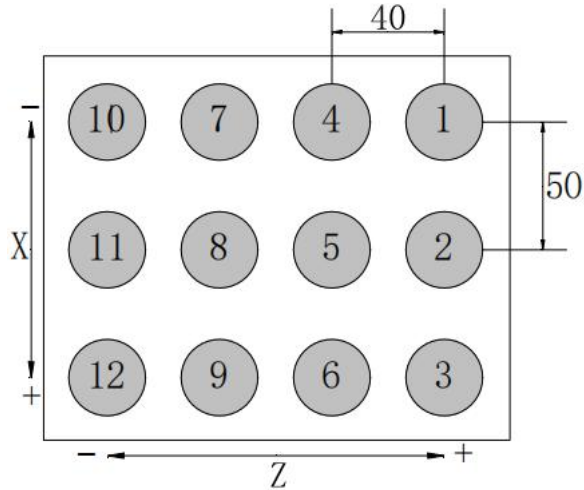

Set value: use group 1 stack

Order: (X-Z-Y) Direction: X positive Z negative Y negative

X axis: spacing 50/3 product Z axis: spacing 40/4 product Y axis: spacing 30/2 layers

According to this setting, the manipulator places products with 50 mm as interval along the X+ direction. Three products (①②③) are in the first line. Then move along the Z- direction for 40 mm and place products. Three products (④⑤⑥) are in the second line. After placing the 12th product in this way, rise for 30mm along Y- direction and repeat the action from the position of ① to place products on the second floor. Therefore, these 24 products can be placed in a cargo box.

Free Stack: You can either set it on this page or set it in Manual-Teaching-Main menu-Stack-Group 7. Free stack is divided into XYZ free stack and XZ free stack.

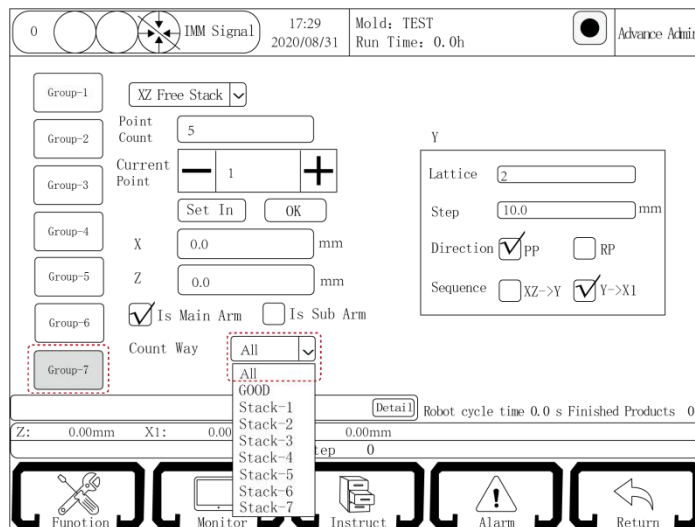

XYZ Free Stack

Point number: the total number of stacks, range (3-30).

X axis: X axis stack position

Y axis: Y axis stack position

Z axis: Z axis stack position

Current Point: The order number of the stack point. As shown above, if set as 1, the position of the first stack point(X,Y,Z) is (110mm,110mm,110mm).

Set In: Click to set the current coordinates as the nth stack position.

OK: After modifying the stack position, click OK button, or the modification fails.

Sub Arm: (1) The program defaults to the main arm stack, that is, only the main arm stacks, the sub arm does not stack.

(2) The X1、Y1 and X2、Y2 are stacked at the same time, with the same number and position.

XZ Free Stack: The X Z axes are free stack, same way to set as the free stack; Y axis is regular stack, same way to set as the regular stack.

Enter Teaching mode and click the stack button to enter the following page:

Stack settings and stack teaching are regardless of order.

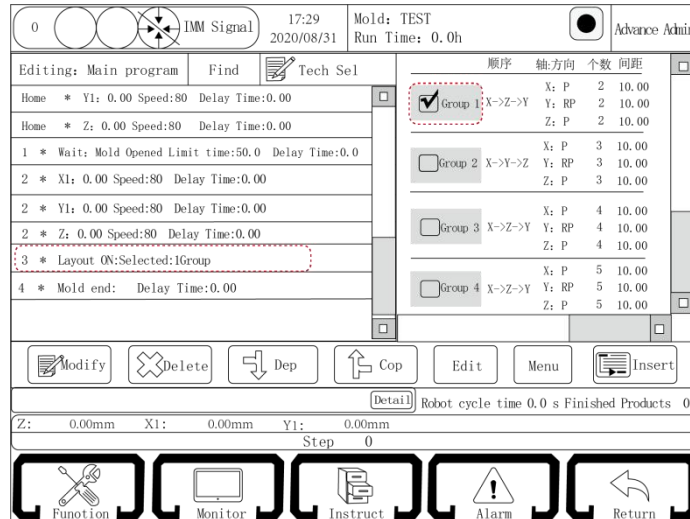

Select the box on the left of the stack program to insert, such as select Group 1, and then click the “insert” button to insert the stack into the program step to start stacking. When running automatically, the manipulator stacks the discharge product according to this stack. When using the Y axis, be sure to insert the stack program into the previous step of the Y axis descending action.

Each automatic program can insert 7 groups of stack programs, which can stack and place products in 7 different locations, and when stacking 7 groups of products, the starting positions should be all 0.

Important: Select the Y axis as the end between the stacks in the system design. Stack program must be inserted before Y axis action. If there are multiple stacks, the Y axis must be inserted between multiple stacks for partition.

For more live stacking examples, please pay attention to the official account.

7.2.10 System Settings

“System Settings” contains five pages: “System Settings”, “Level Management”, “Admin Settings”, “BackUp/Restore” and “Ghost”.

(1) The System Settings page, shown as below :

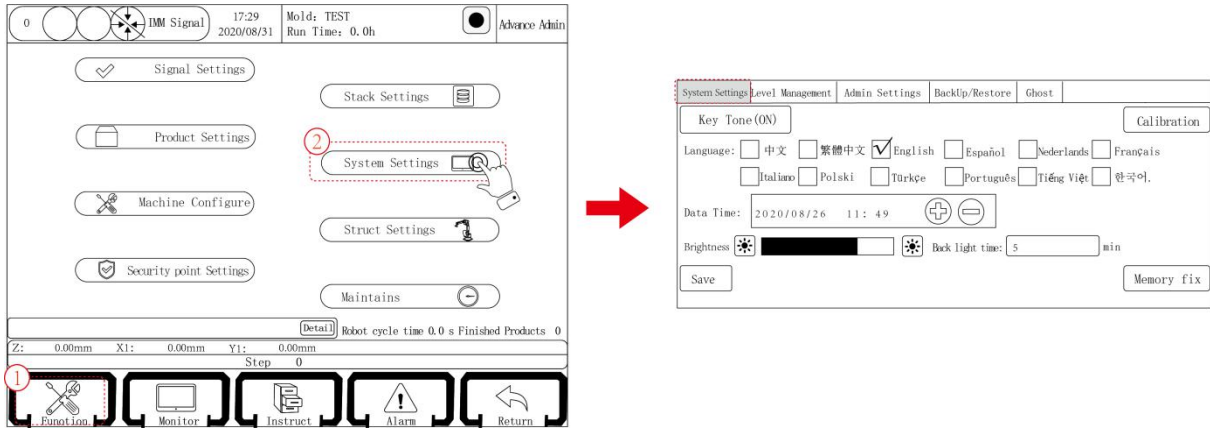

Tip: If not able to copy or delete program into the file, click “Storage Repair”. The system will automatically restart the function.

Key Tone: Open/close key tone.

Language: 12 languages for customers to choose, default in Chinese.

Date: Date and time displayed. Select and press or subtract key to change and click save, after about 2 minutes, then it will be updated to a new time.

Back light time: The screen turns dark if the time set is over and “Senior Admin” permissions becomes “Admin” permissions.

Brightness: Adjust the brightness of the display screen, click the left screen is dimmed out, and click the right screen turns bright.

Version mode: Show the version of manual controller and the host.

Touch calibration: When the screen cursor is inaccurate, it can be calibrated.

Important: If the cursor deviates from the page, use the key sequence to correct.

1. After the system is fully started, twist the third switch to stop.
2. Press F5 F1 F4 F1 F3 F1 F2 F5, system will automatically restart into the correction screen page.

Memory fix: When pressed, the storage repair will be started automatically. (for case that unable to start a new mold number)

(2) Permission management page. As shown below:

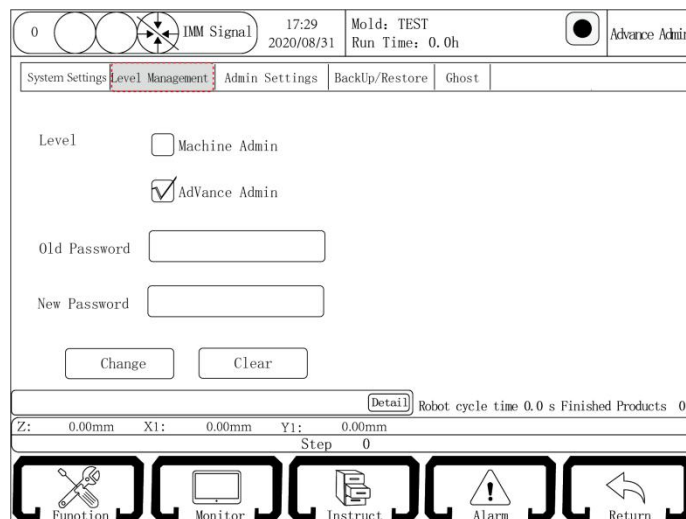

Permissions: Divided into administrators and senior administrators; administrators can change basic parameters, but have no right to teach programs, change mechanical parameters, and enter maintenance pages, and senior administrators can change any parameters.

Old password/new password: Enter the old password, and then enter the new password, press the change key to change the password. (If you modify the administrator password. If under advanced administrator permission, enter the new password directly)

(3) Advanced Administrator Options page, as shown below :

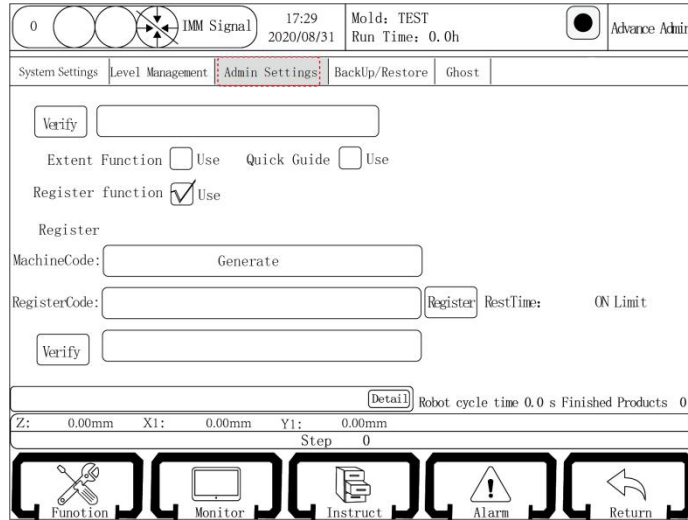

Verify: Enter szhc2a in the text box next to the validation button, and click the button. The “function extension”, “quick instruction” and “registration” change from gray to black.

Extent Function: When checked, the main menu of the edit page in manual state has 12 sub-pages; if not checked, the “condition” and “sequence action” of the main menu page will be hidden and the function can not be used.

If you need to register, please contact our technical staff. It needs to change manufacturer code before register and power off to restart after finish register.

(4) Backup/restore pages. As shown below:

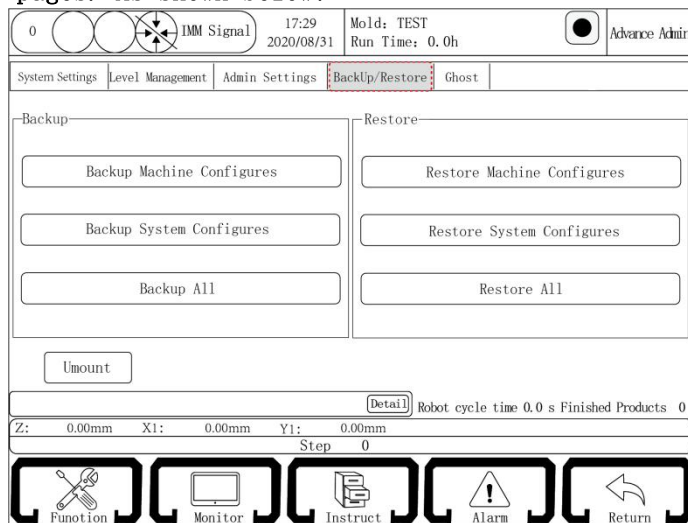

USB can be used under this page to backup and restore machine parameters, system parameters, and all parameters, respectively. After the parameter is restored, the controller will restart automatically.

(5) Ghost functions, as shown below:

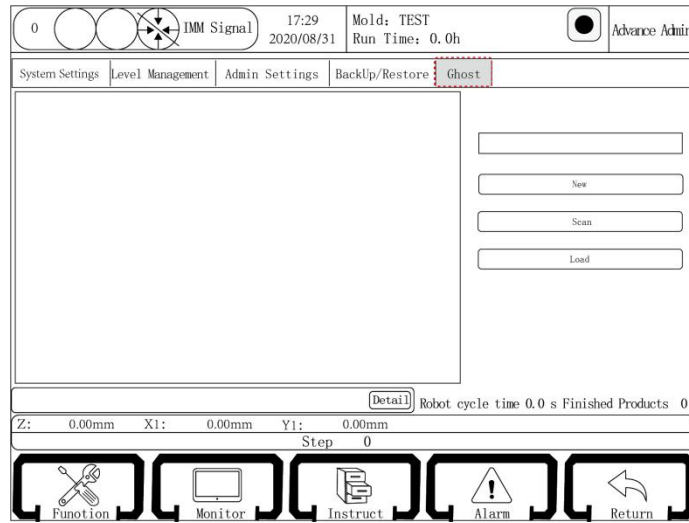

New: Enter a name in the red box and click the new button to backup all the parameters on the manual controller, including the manual program, to the USB(insert the USB first).

Scan: Scan the backup Ghost file (insert USB) and the backup file appears in the blue box.

Load: Select the file, click load and a dialog box will pop up when completed. Then click confirm in the box, the system will restart and current program will return to backup program in Ghost file. (If the current manual control program is 6.6.6, back up the Ghost file and then upgrade to 6.7.2. After loading the backup Ghost file, the system will reboot and the manual control program will be 6.6.6).

7.2.11 Maintenance

(1) Maintenance page, as shown below:

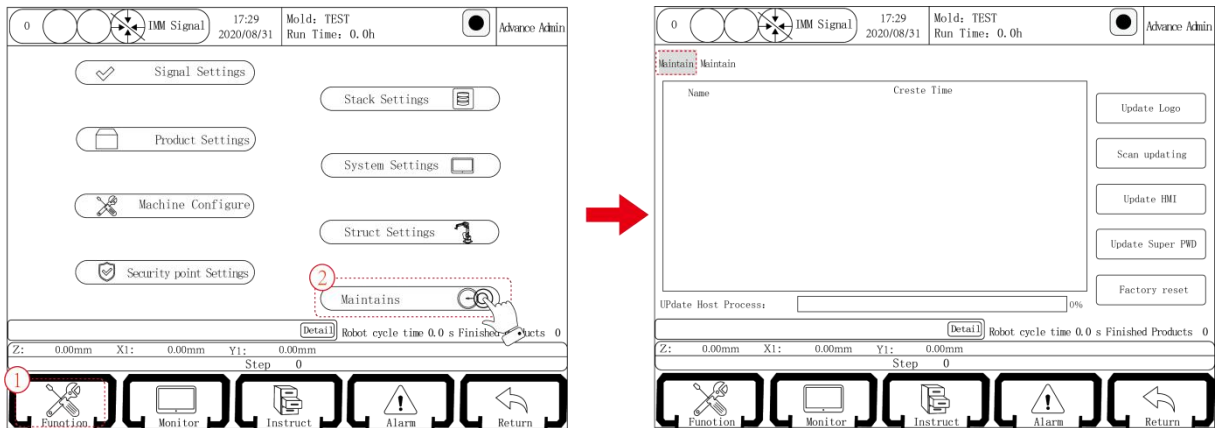

Under this page, the system can upgrade and renew pictures.

Update description: The upgrade program is copied into the USB disk. Insert USB after the controller is power on. Log on senior administrator and turn the knob to Stop, then enter Function — Maintenance. Click scan update package, after the version number shows, select the version and then click to start updating. The system will automatically restart. Pull out USB.

Start page and standby page update description:

1. Start new HCUupdate_pic in the root directory in USB to copy the images to be shown on the home screen into the folder; (Note: start page picture needs 800*600, standby page picture needs 800*400, png format)
2. Insert the USB onto the manual controller;
3. Click update picture, pop up picture update box, click scan picture;
4. Select the picture for standby page, click “choose”, it will pop up “set up successfully, effective after restart”. Select the picture for start page, click “choose”, it will pop up “set up successfully, effective after restart”. Then exit and restart the system.

Factory reset: This function is not in standard configuration.

(2) Maintenance page , as shown below :

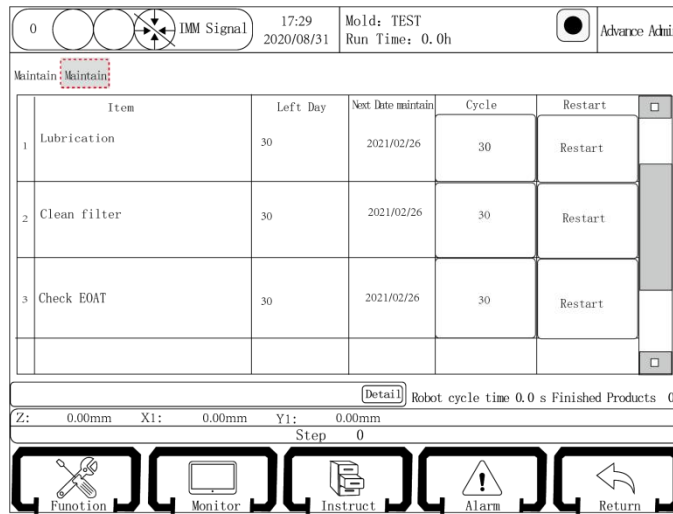

In this page, set the maintenance cycle and the cycle is calculated by natural days. If a certain maintenance period is reached, the system will prompt, after maintenance, click “restart” to re-timing.

Chapter 8 Automatic Status

8.1 Monitoring of Auto-running Data

Turn the status selection switch to the automatic gear, then the robot enters the automatic standby state. Press the start button again and the robot will start to run automatically. It is able to monitor the robot's operation data in automatic state. The automatic operation page displays the following:

Step	Description	Speed	Delay Time
Home	* Vertical posture 1:		Delay Time:0.00
Home	* X1:	0.00 Speed:80	Delay Time:0.00
Home	* Y1:	0.00 Speed:80	Delay Time:0.00
Home	* Z:	0.00 Speed:80	Delay Time:0.00
1	* Wait: Mold Opened Limit time		Delay Time:0.00
2	* X1:	0.00 Speed:80	Delay Time:0.00
3	* Check: ON Defective Products Go toFlag[0]Limit time:0.00		
4	* #Flag[0]:Comment:		
5	* Mold end:		Delay Time:0.00

Control buttons: Edit, No Follow, Single Step, Cycle, Speed disable.

Statistics: Robot cycle time 0.0 s, Finished Products 0.

Production Data: Setted products 1000, Good products 0, Stackd products 0.

Navigation: Function, Monitor, Instruct, Alarm, Return.

Time: Record the molding cycle time of the last period.

Fetch time: Time from when the mold opened signal is on to when the program of mold locked ends, that is, from when the mold closable signal is off to on.

Set production: The target output set currently.

Good products: The number of qualified products that have been taken by the robot. (If there is no reject signal before the mold is finished, it is good product)

Stacked products: Number of products stacked by the robot when operating stack.

8.2 Modification of Parameters in Automatic Operation

In automatic running state, the time of action, speed and position of the electric shaft can be modified according to the current running condition. To facilitate the modification of parameters, click "do not follow" button to stop the program running indicator bar movement.

Click the line where the action locates to modify the parameter. Select and then click the Edit button to pop up the following dialog box:

Dialog

2 * X1: 300.00 Speed: 80 Delay: 0.00

Delay Time: 0.00 s

Speed: 80 %

Pos (+/-5) : 0.0 mm

Buttons: OK, Cancel

In this dialog box, you can modify the delay time of the action, speed and position of the electric shaft. Change the parameters and click OK, then the parameters will be accepted online and it will operate according to the changed parameters in the next cycle. Press Cancel key to cancel the action.

To ensure that the modification of the position of the electric shaft will not damage the manipulator, injection molding machine and modules, the change is limited within ± 5 mm each time.

8.3 Single Step Operation

Turn the knob to automatic state, click the “Single Step” button, and then press the “Start” button to enter the single-step operation mode. In this mode, every time the “Single Step” button is clicked, the program of automatic action will be executed by a step. The automatic program executed is the automatic program currently taught.

The single-step running mode can be used to confirm step by step whether the program being taught is correct.

8.4 Single Cycle

In the automatic state, click “Cycle”, and then press “Start” to enter the single cycle operation mode, automatic mode after the automatic operation.

8.5 Speed Adjustment during Automatic Operation

When running automatically, click “Speed Disable” button to make it “Speed Enable”. The upper and lower speed adjustment keys on the selection panel can increase or decrease the overall speed of the automatic running. The overall speed can be adjusted to 200 at most.

Chapter 9 Monitor and Alarm Record

9.1 I/O Monitor

Click the “**Monitor**” button at the bottom of the screen to enter the monitoring page of the I/O signal. The page is divided into manipulator I/O signal, injection molding machine I/O signal and servo parameters. I/O status is as follows:

Servo parameter monitoring page:

Parameter	Value	Unit
X P Diff	1	pu
X SPD	1	RPM
X OLR	1	%
X LR	1	%
X TEMP	0.1	°C
X VDC	0.1	V
X Feedback	0	pu
X TRQ	0.04	%

You can monitor the position deviation, speed and load rate of each axis on this page.

9.2 Alarm History

Click the “**Alarm history**” button at the bottom of the screen to enter the alarm screen. As shown below:

Alarm Number	Alarm Information	Alarm Date/Time	Alarm Modify Time
1	Lost contact with MainCtrl!	20-12-02 14:08	no-solve
2	Lost contact with MainCtrl!	20-12-02 14:08	no-solve
3	Lost contact with MainCtrl!	20-12-02 14:08	no-solve
4	Lost contact with MainCtrl!	20-12-02 14:08	no-solve
5	Lost contact with MainCtrl!	20-12-02 14:08	no-solve
6	Lost contact with MainCtrl!	20-12-02 14:08	no-solve
7	Lost contact with MainCtrl!	20-12-02 14:08	no-solve
8	Lost contact with MainCtrl!	20-03-11 16:12	no-solve
9	Lost contact with MainCtrl!	20-03-11 15:44	no-solve
10	Lost contact with MainCtrl!	19-07-22 14:19	no-solve
11	Lost contact with MainCtrl!	19-07-22 14:19	no-solve
12	Lost contact with MainCtrl!	19-07-22 14:19	no-solve
13	Lost contact with MainCtrl!	19-07-22 14:19	no-solve

When the alarm appears, click on the help in the alarm bar, and it will automatically pop up the prompt box, alarm details and solutions. As shown below:

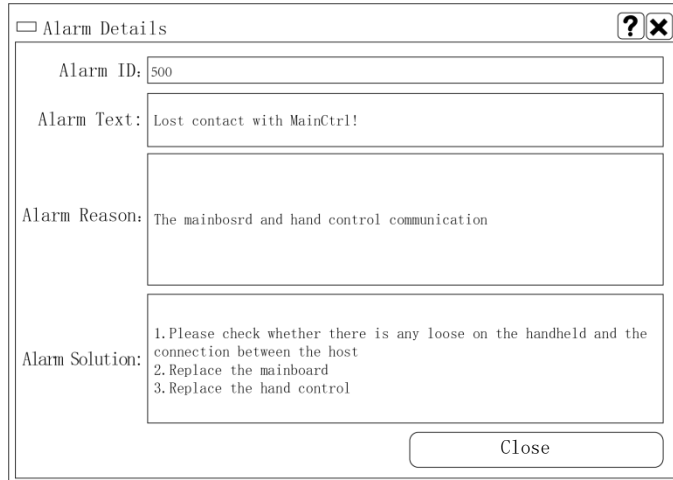

The control system can record the latest 200 alarms, which is convenient for users to find the manipulator history alarm information.

9.3 Modify Log

Click the button “Modify Log” at the bottom of the screen to enter the modified record screen. As shown below:

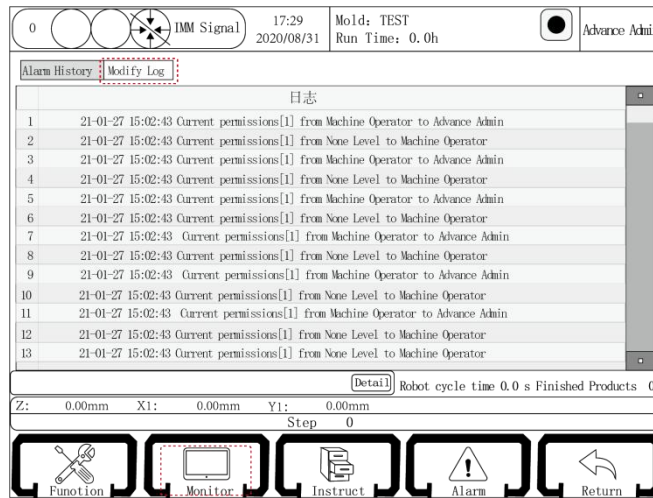

The control system can record the latest 200 modification records to facilitate the user to find information about the manipulator history modification.

9.4 Alarms and Solutions

Function alarm and solution

Alarm Number	Alarm Information	Alarm Reason	Alarm Solution
1	Virtual Error	None	None
2	Strange Characters	None	None
3	Program no end	None	None
4	Ignored characters	None	None
5	Coord chaos	None	None
6	No end position	None	None
7	Arc definition	None	None
8	Order	None	None
9	Radius mismatch	None	None
10	Over speed	Output pulse command frequency >600 K	Deceleration
11	Double Define IO	None	None
12	None Define IO	None	None
13	Group Action is error	The same action steps are combined.	Decompose the same action or delete one
14	Group standby is error	The standby point combination contains the same action	Decompose the same action or delete one
15	Fetch next step wrong	The teaching steps are abnormal	Action deleted
16	Check end out of range	None	Please contact our technicians
17	Register contact is wrong	None	Please contact our technicians
18	Check main action end	None	Please contact our technicians
19	Register NUM contact is wrong	None	Please contact our technicians
20	Register Sub contact is wrong	None	Please contact our technicians
21	Register action has finished	None	Please contact our technicians
22	X is still running when generate action	The same combination action contains two X axis motion commands	Decompose or delete an X axis action
23	Y is still running when generate action	The same combination action contains two Y action instruction	Decompose or delete a Y axis action
24	Z is still running when generate action	The same combination action contains two Z axis motion commands	Decompose or delete a Z axis action
25	The timer has been cleared when G has delay time	Axis action has a delay, but because the counter is 0, the counter can not delay	Please contact our technicians
26	X over-speed	The same combination action contains two X axis motion commands	Deceleration

27	Y over-speed	The same combination action contains two Y action instruction	Deceleration
28	Z over-speed	The same combination action contains two Z axis motion commands	Deceleration
29	Register write overtime	An exception of stored parameter writes	Please contact our technicians
30	Debug fail		Please contact our technicians
60	A over-speed	Instruction output pulse frequency > 600 k	Deceleration
61	B over-speed	Instruction output pulse frequency > 600 k	Deceleration
62	C over speed	Instruction output pulse frequency > 600 k	Deceleration
63	A is still running when generate action	The same combination action contains two axis motion commands A	Decompose or delete an A axis action
64	B is still running when generate action	The same combination action contains two B axis motion commands	Decompose or delete a B axis action
65	C is still running when generate action	The same combination action contains two C axis motion commands	Decompose or delete a C axis action
70	X2 over-speed	Instruction output pulse frequency > 600 k	Deceleration
71	Y2 over-speed	Instruction output pulse frequency > 600 k	Deceleration
72	X2 is still running when generate action	The same combination action contains two X2 axis motion commands	Decompose or delete X2 axis action
73	Y2 is still running when generate action	The same combination action contains two Y2 axis motion commands	Decompose or delete Y2 axis action
100	X axis feedback pulse deviation is too large	Difference of counter between pulse command and feedback pulse command is larger than set value	<p>1. If the alarm can be removed, please check whether the tolerance is too small (function - running parameters - increase "tolerance" parameter), servo rigidity is too soft. (dynamic following is bad)</p> <p>2. If the alarm cannot be removed, please use the positive/negative pulse test, there may be a connection problem causing pulse missing or servo feedback pulse direction is not correct. (motor forward feedback is 10000, reverse feedback is 55535)</p>

101	Y axis feedback pulse deviation is too large	Difference of counter between pulse command and feedback pulse command is larger than set value	<p>1. If the alarm can be removed, please check whether the tolerance is too small (function - running parameters - increase "tolerance" parameter), servo rigidity is too soft. (dynamic following is bad)</p> <p>2. If the alarm cannot be removed, please use the positive and negative pulse test, there may be a connection problem causing pulse missing or servo feedback pulse direction is not correct. (motor forward feedback is 10000, reverse feedback is 55536)</p>
102	Z axis feedback pulse deviation is too large	Difference of counter between pulse command and feedback pulse command is larger than set value	<p>1. If the alarm can be removed, please check whether the tolerance is too small (function - running parameters - increase "tolerance" parameter), servo rigidity is too soft. (dynamic following is bad)</p> <p>2. If the alarm cannot be removed, please use the positive and negative pulse test, there may be a connection problem causing pulse missing or servo feedback pulse direction is not correct. (motor forward feedback is 10000, reverse feedback is 55537)</p>
103	X axis Z pulse error	None	None
104	Y axis Z pulse error	None	None
105	Z axis Z pulse error	None	None
106	X servo driver alarm	X axis driver alarm	<p>1. The servo driver alarms, find reason, solve the servo driver alarm.</p> <p>2. The servo driver has no alarm, check whether the main board and servo driver connection is loose or have welding problem.</p> <p>3. The servo driver has no alarm, the wire is normal. Replace the main board.</p>
107	Y servo driver alarm	Y axis driver alarm	<p>1. The servo driver alarms, find reason, solve the servo driver alarm.</p> <p>2. The servo driver has no alarm, check whether the main board and servo driver connection is loose or have welding problem.</p> <p>3. The servo driver has no alarm, the wire is normal. Replace the main board.</p>

108	Z servo driver alarm	Z axis driver alarm	<p>1.The servo driver alarms, find reason, solve the servo driver alarm.</p> <p>2.The servo driver has no alarm, check whether the main board and servo driver connection is loose or have welding problem.</p> <p>3.The servo driver has no alarm, the wire is normal. Replace the main board.</p>
109	X Not moved into place	Act before X axis moves to the expected position	Please contact our technicians
110	Y Not moved into place	Act before Y axis moves to the expected position	Please contact our technicians
111	Z Not moved into place	Act before Z axis moves to the expected position	Please contact our technicians
112	X-Max alarm	The X axis end limit has no signal	<p>1.Check the limit switch.</p> <p>2.The limit is normally closed, check whether the short connection is normal.</p>
113	X-Min alarm	The X axis starting point limit has no signal	<p>1. Check the limit switch.</p> <p>2.The limit is normally closed, check whether the short connection is normal.</p>
114	Y-Max alarm	The Y axis end limit has no signal	<p>1. Check the limit switch.</p> <p>2.The limit is normally closed, check whether the short connection is normal.</p>
115	Y-Min alarm	The Y axis starting point limit has no signal	<p>1. Check the limit switch.</p> <p>2.The limit is normally closed, check whether the short connection is normal.</p>
116	Z-Max alarm	The Z axis end limit has no signal	<p>1. Check the limit switch.</p> <p>2.The limit is normally closed, check whether the short connection is normal.</p>
117	Z-Min alarm	The Z axis starting point limit has no signal	<p>1. Check the limit switch.</p> <p>2.The limit is normally closed, check whether the short connection is normal.</p>
118	X-Pos too large	The current position is greater than the max X movement	<p>1.Please check the relative security point setting. The alarm may appear when turning tuning knob in max/min position.</p> <p>2.Move toward opposite direction after removing the alarm.</p>
119	X-Pos too small	The current position is less than the min X axis movement	<p>1.Please check the relative security point setting. The alarm may appear when turning tuning knob in max/min position.</p> <p>2.Move toward opposite direction after removing the alarm.</p>

120	Y-Pos too large	The current position is greater than the max Y axis movement	<ol style="list-style-type: none"> 1.Please check the relative security point setting. The alarm may appear when turning tuning knob in max/min position. 2. Move toward opposite direction after removing the alarm.
121	Y-Pos too small	Current position is less than the min Y axis movement	<ol style="list-style-type: none"> 1.Please check the relative security point setting. The alarm may appear when turning tuning knob in max/min position. 2. Move toward opposite direction after removing the alarm.
122	Z-Pos too large	Current position is greater than the max Z axis movement	<ol style="list-style-type: none"> 1.Please check the relative security point setting. The alarm may appear when turning tuning knob in max/min position. 2. Move toward opposite direction after removing the alarm.
123	Z-Pos too small	Current position is less than the min Z axis movement	<ol style="list-style-type: none"> 1.Please check the relative security point setting. The alarm may appear when turning tuning knob in max/min position. 2. Move toward opposite direction after removing the alarm.
124	X position is set too large when running	Stacked points interval is set wrong and over the max or min position	Check the number of stacked points and interval
125	X position is set too small when running	Stacked points interval is set wrong and over the max or min position	Check the number of stacked points and interval
126	Y position is set too large when running	Stacked points interval is set wrong and over the max or min position	Check the number of stacked points and interval
127	Y position is set too small when running	Stacked points interval is set wrong and over the max or min position	Check the number of stacked points and interval
128	Z position is set too large when running	Stacked points interval is set wrong and over the max or min position	Check the number of stacked points and interval
129	Z position is set too small when running	Stacked points interval is set wrong and over the max or min position	Check the number of stacked points and interval
130	X Axis memory error	X axis parameters memory error	Function – mechanical parameters – [X] page save again
131	Y Axis memory error	Y parameters memory error.	Function – mechanical parameters – [Y] page save again
132	Z Axis memory error	Z axis parameters memory error.	Function– mechanical parameters – [Z] page save again

133	Struct memory error	The host shaft parameters memory error	Function - mechanical parameters - save all the parameters of the shaft
134	X axis compare	Host X axis parameters do not agree with the parameters in hand controller	Function - mechanical parameters - [X] page save again
135	Y axis compare	Host Y axis parameters do not agree with the parameters in hand controller	Function - mechanical parameters - [Y] page save again
136	Z axis compare	The host Z axis parameters do not match the parameters of the manual controller	Function - mechanical parameters - [Z] page save again
137	Struct compare	Host axis parameters do not agree with the parameters of the manual controller	Function - mechanical parameters - save all the parameters of the shaft
138	X is not servo	Servo axis is not opened in X axis. No teaching step for X axis in teaching program	1. Function - Mechanical parameter - open X axis as servo axis in axis definition 2. Delete actions of X axis in teaching
139	Y is not servo	Servo axis is not opened in Y axis. No teaching step for Y axis in teaching program	1. Function - Mechanical parameter - open Y axis as servo axis in axis definition 2. Delete actions of Y axis in teaching
140	Z is not servo	Servo axis is not opened in Z axis. No teaching step for Z axis in teaching program	1. Function - Mechanical parameter - open Z axis as servo axis in axis definition 2. Delete actions of Z axis in teaching
141	X axis not enabled	X axis enable is cut off	Enable X axis
142	Y axis not enabled	Y axis enable is cut off	Enable X axis
143	Z axis not enabled	Z axis enable is cut off	Enable X axis
160	X2 axis feedback pulse deviation is too large	Difference of counter between pulse command and feedback pulse command is larger than set value	1. If the alarm can be removed, please check whether the tolerance is too small (function - running parameters - increase "tolerance" parameter), servo rigidity is too soft. (dynamic following is bad) 2. If the alarm cannot be removed, please use the positive and negative pulse test, there may be a connection problem causing pulse missing or servo feedback pulse direction is not correct. (motor forward feedback is 10000, reverse feedback is 55537)

161	Y2 axis feedback pulse deviation is too large	Difference of counter between pulse command and feedback pulse command is larger than set value	<p>1.If the alarm can be removed, please check whether the tolerance is too small (function - running parameters - increase “tolerance” parameter), servo rigidity is too soft. (dynamic following is bad)</p> <p>2.If the alarm may not clear, please use the positive and negative pulse test, there may be a connection problem cause pulse missing or servo feedback pulse direction is not correct. (motor forward feedback is 10000, reverse feedback is 55535)</p>
162	X2 axis Z signal	None	None
163	Y2 axis Z signal	None	None
164	X2 servo driver alarm	X2 axis driver alarm	<p>1.The servo driver alarms, find reason, solve the servo driver alarm.</p> <p>2.The servo driver has no alarm, check whether the main board and servo driver connection is loose or have welding problem.</p> <p>3.The servo driver has no alarm, the wire is normal. Replace the main board.</p>
165	Y2 servo driver alarm	Y2 shaft driver the police	<p>1.The servo driver alarms, find reason, solve the servo driver alarm.</p> <p>2.The servo driver has no alarm, check whether the main board and servo driver connection is loose or have welding problem.</p> <p>3.The servo driver has no alarm, the wire is normal. Replace the main board.</p>
166	X2 missed pos	Act before X2 axis moves to the taught position	Please contact our technicians
167	Y2 missed pos	Act before Y2 axis moves to the taught position	Please contact our technicians
168	X2-Max alarm	X2 shaft end limit has no signal	<p>1.Check the limit switch is normal.</p> <p>2.The limit is normally closed, check whether the short connection is normal.</p>
169	X2-Min alarm	X2 axis starting point limit has no signal	<p>1.Check the limit switch.</p> <p>2.The limit is normally closed, check whether the short connection is normal.</p>
170	Y2-Max alarm	Y2 shaft end limit has no signal	<p>1.Check the limit switch.</p> <p>2.The limit is normally closed, check whether the short connection is normal.</p>
171	Y2-Min alarm	Y2 axis starting point limit has no signal	<p>1.Check the limit switch.</p> <p>2.The limit is normally closed, check whether the short connection is normal.</p>

172	X2-Pos too large	Current position is larger than the max X2 axis movement	<p>1. Please check the relative security point setting. The alarm may appear when turning tuning knob in max/min position.</p> <p>2. Move toward opposite direction after removing the alarm.</p>
173	X2-Pos too small	Current position is less than the min X2 axis movement	<p>1. Please check the relative security point setting. The alarm may appear when turning tuning knob in max/min position.</p> <p>2. Move toward opposite direction after removing the alarm.</p>
174	Y2-Pos too large	Current position is larger than the max Y2 axis movement	<p>1. Please check the relative security point setting. The alarm may appear when turning tuning knob in max/min position.</p> <p>2. Move toward opposite direction after removing the alarm.</p>
175	Y2-Pos too small	Current position is less than the min Y2 axis movement	<p>1. Please check the relative security point setting. The alarm may appear when turning tuning knob in max/min position.</p> <p>2. Move toward opposite direction after removing the alarm.</p>
176	X2 position is set too large when running	Stacked points interval is set wrong and over the max or min position	Check the number of stacked points and interval
177	X2 position is set too small when running	Stacked points interval is set wrong and over the max or min position	Check the number of stacked points and interval
178	Y2 position is set too large when running	Stacked points interval is set wrong and over the max or min position	Check the number of stacked points and interval
179	Y2 position is set too small when running	Stacked points interval is set wrong and over the max or min position	Check the number of stacked points and interval
180	X2 Axis memory error	X2 axis parameters memory error	Function - mechanical parameters - [X2] page save again
181	Y2 Axis memory error	Y2 axis parameters memory error	Function - mechanical parameters - [Y2] page save again
182	X2 axis compare	Host X2 axis parameters do not agree with the parameters in hand controller	Function - mechanical parameters - [X2] page save again

183	Y2 axis compare	Host X axis parameters do not agree with the parameters in hand controller	Function - mechanical parameters - [Y2] page save again
184	X2 is not servo	Servo axis is not opened in X2 axis. There is step for X2 axis in teaching program	<ol style="list-style-type: none"> 1.Function - Mechanical parameter - open X2 axis as servo axis in axis definition 2.Delete actions of X2 axis in teaching
185	Y2 is not servo	Servo axis is not opened in Y2 axis. There is step for Y2 axis in teaching program	<ol style="list-style-type: none"> 1.Function - Mechanical parameter - open Y2 axis as servo axis in axis definition 2.Delete actions of Y2 axis in teaching
200	A axis feedback pulse deviation is too large	Difference of counter between pulse command and feedback pulse command is larger than set value	<ol style="list-style-type: none"> 1.If the alarm can be removed, please check whether the tolerance is too small (function - running parameters - increase "tolerance" parameter), servo rigidity is too soft. (dynamic following is bad) 2.If the alarm may not clear, please use the positive and negative pulse test, there may be a connection problem cause pulse missing or servo feedback pulse direction is not correct. (motor forward feedback is 10000, reverse feedback is 55535)
201	B axis feedback pulse deviation is too large	Difference of counter between pulse command and feedback pulse command is larger than set value	<ol style="list-style-type: none"> 1.If the alarm can be removed, please check whether the tolerance is too small (function - running parameters - increase "tolerance" parameter), servo rigidity is too soft. (dynamic following is bad) 2.If the alarm may not clear, please use the positive and negative pulse test, there may be a connection problem cause pulse missing or servo feedback pulse direction is not correct. (motor forward feedback is 10000, reverse feedback is 55535)

202	C axis feedback pulse deviation is too large	Difference of counter between pulse command and feedback pulse command is larger than set value	<p>1. If the alarm can be removed, please check whether the tolerance is too small (function - running parameters - increase "tolerance" parameter), servo rigidity is too soft. (dynamic following is bad)</p> <p>2. If the alarm may not clear, please use the positive and negative pulse test, there may be a connection problem cause pulse missing or servo feedback pulse direction is not correct. (motor forward feedback is 10000, reverse feedback is 55535)</p>
203	A axis Z pulse error	None	None
204	B axis Z pulse error	None	None
205	C axis Z pulse error	None	None
206	A-servo alarm	A axis servo driver alarms	<p>1. The servo driver alarms, find reason, solve the servo driver alarm.</p> <p>2. The servo driver has no alarm, check whether the main board and servo driver connection is loose or have welding problem.</p> <p>3. The servo driver has no alarm, the wire is normal. Replace the main board.</p>
207	B-servo alarm	B axis servo driver alarms	<p>1. The servo driver alarms, find reason, solve the servo driver alarm.</p> <p>2. The servo driver has no alarm, check whether the main board and servo driver connection is loose or have welding problem.</p> <p>3. The servo driver has no alarm, the wire is normal. Replace the main board.</p>
208	C-servo alarm	C axis servo driver alarms	<p>1. The servo driver alarms, find reason, solve the servo driver alarm.</p> <p>2. The servo driver has no alarm, check whether the main board and servo driver connection is loose or have welding problem.</p> <p>3. The servo driver has no alarm, the wire is normal. Replace the main board.</p>
209	A missed pos	Do the next step before the A axis moves in place	Please contact our technicians
210	B missed pos	Do the next step before the B axis moves in place	Please contact our technicians
211	C missed pos	Do the next step before the C axis moves in place	Please contact our technicians
212	A-Max alarm	The A axis end limit has no signal	<p>1. Check the limit switch.</p> <p>2. The limit is normally closed, check whether the short connection is normal.</p>

213	A-Min alarm	The A axis starting point limit has no signal	<ol style="list-style-type: none"> 1. Check the limit switch. 2. The limit is normally closed, check whether the short connection is normal.
214	B-Max alarm	The B axis end limit has no signal	<ol style="list-style-type: none"> 1. Check the limit switch. 2. The limit is normally closed, check whether the short connection is normal.
215	B-Min alarm	The B axis starting point limit has no signal	<ol style="list-style-type: none"> 1. Check the limit switch. 2. The limit is normally closed, check whether the short connection is normal.
216	C-Max alarm	The C axis end limit has no signal	<ol style="list-style-type: none"> 1. Check the limit switch. 2. The limit is normally closed, check whether the short connection is normal.
217	C-Min alarm	The C axis starting point limit has no signal	<ol style="list-style-type: none"> 1. Check the limit switch. 2. The limit is normally closed, check whether the short connection is normal.
218	A-Pos too large	Current position is larger than the max A axis movement	<ol style="list-style-type: none"> 1. Please check the relative security point setting. The alarm may appear when turning tuning knob in max/min position. 2. Move toward opposite direction after removing the alarm.
219	A-Pos too small	Current position is less than the min A axis movement	<ol style="list-style-type: none"> 1. Please check the relative security point setting. The alarm may appear when turning tuning knob in max/min position. 2. Move toward opposite direction after removing the alarm.
220	B-Pos too large	Current position is larger than the max B axis movement	<ol style="list-style-type: none"> 1. Please check the relative security point setting. The alarm may appear when turning tuning knob in max/min position. 2. Move toward opposite direction after removing the alarm.
221	B-Pos too small	Current position is less than the min B axis movement	<ol style="list-style-type: none"> 1. Please check the relative security point setting. The alarm may appear when turning tuning knob in max/min position. 2. Move toward opposite direction after removing the alarm.
222	C-Pos too large	Current position is larger than the max C axis movement	<ol style="list-style-type: none"> 1. Please check the relative security point setting. The alarm may appear when turning tuning knob in max/min position. 2. Move toward opposite direction after removing the alarm.
223	C-Pos too small	Current position is less than the min C axis movement	<ol style="list-style-type: none"> 1. Please check the relative security point setting. The alarm may appear when turning tuning knob in max/min position. 2. Move toward opposite direction after removing the alarm.
224	A position set too large	Stacked points interval is set wrong and over the max or min position	Check the number of stacked points and interval

225	A position set too small	Stacked points interval is set wrong and over the max or min position	Check the number of stacked points and interval
226	B position set too large	Stacked points interval is set wrong and over the max or min position	Check the number of stacked points and interval
227	B position set too small	Stacked points interval is set wrong and over the max or min position	Check the number of stacked points and interval
228	C position set too large	Stacked points interval is set wrong and over the max or min position	Check the number of stacked points and interval
229	C position set too small	Stacked points interval is set wrong and over the max or min position	Check the number of stacked points and interval
230	A Axis memory error	A axis parameters memory error	Function - mechanical parameters - [A] page save again
231	B Axis memory error	B axis parameters memory error	Function - mechanical parameters - [B] page save again
232	C Axis memory error	C axis parameters memory error	Function - mechanical parameters - [C] page save again
233	SPI NULL	None	None
234	A axis compare	Host A axis parameters do not agree with the parameters in hand controller	Function - mechanical parameters - [A] page save again
235	B axis compare	Host B axis parameters do not agree with the parameters in hand controller	Function - mechanical parameters - [B] page save again
236	C axis compare	Host C axis parameters do not agree with the parameters in hand controller	Function - mechanical parameters - [C] page save again
237	COMPARE NULL	None	None
238	A is not servo	Servo axis is not opened in A axis but there is teaching action	1. Function - Mechanical parameter - open A axis as servo axis in axis definition 2. Delete actions of A axis in teaching
239	B is not servo	Servo axis is not opened in B axis but there is teaching action	1. Function - Mechanical parameter - open B axis as servo axis in axis definition 2. Delete actions of B axis in teaching
240	C is not servo	Servo axis is not opened in C axis but there is teaching action	1. Function - Mechanical parameter - open B axis as servo axis in axis definition 2. Delete actions of B axis in teaching
300	X axis is set incorrectly	The X axis mechanical parameter is set wrong	Function - mechanical parameters - [X axis] page to reset
301	Y axis is set incorrectly	Y mechanical parameter is set wrong	Features - mechanical parameters - [Y axis] page to reset

302	Z axis is set incorrectly	The Z axis mechanical parameter is set wrong	Features – mechanical parameters – [Z axis] page to reset
303	Action checksum error!	Modification of teaching is not sent to host in automatic state	Contact for technical support
304	Emergency Stop!	Emergency stop signal input	<ol style="list-style-type: none"> 1. Check if the stop switch on the manual controller spun out 2. Check the connection between manual controller and main board 3. Check whether injection molding machine emergency stop has input 4. Check the main power supply
305	Main cycle error	Error in host initialization	Restart the host
306	Standby Point position error	Starting point in mold number does not agree with axis definition in Function – Mechanical param- Struct	<ol style="list-style-type: none"> 1. Create a new model number 2. Y standby position should be less than the max standby position
307	Fetching act error	Error	Restart
308	Too large tolerance	If the tolerance is more than 10 mm, it will send an alarm	<ol style="list-style-type: none"> 1. The touch tolerance must be less than 10mm 2. Three-axis/Five-axis system tolerance must be less than 100mm
309	Mold Function parameter error	Mold parameter between host and manual controller are inconsistent	Create new mold number
310	iSub too large	Abnormal subprogram	Create new mold number
311	iSub nesting	Abnormal subprogram	Create new mold number
312	Illegal stack	Stack without teaching	Please contact our technicians
313	Overlapping stack	Steps of stack are combined	Decompose stack action steps
314	Action sequence is wrong	Sequence in running does not agree with sequence stored	Please contact our technicians
315	System parameter is wrong	In two axis touch system, operation parameters – tolerance is too large, no more than 10	The tolerance is set less than 10mm
316	Action sequence is wrong	Sequence in running does not agree with sequence stored	Please contact our technicians
317	Action sequence is wrong	Sequence in running does not agree with sequence stored	Please contact our technicians
318	Single command juxtaposed	Steps of wait and condition program are combined	Discompose these steps

319	Only run in auto	Allow teaching in non -automatic state	Switch to automatic state when running
320	Call abnormal SEQ	Value of return step number that exceeds the last step of program overflows	Check return step number when using condition function
321	Wrong checksum in call	Checksum is inconsistent with host while running	Please contact our technicians
322	Wrong GM checksum in call	Checksum is inconsistent with host while running	Please contact our technicians
323	Wait Mold Opened	No step of "Wait mold opened" in mold number program	Inset the step into the program
324	Wrong GEM in auto adjustment	Manual controller does not agree with host while operating axis action	Please contact our technicians
325	Clip action is duplicated	The action steps of the same fixture are combined	Decompose the synchronous action steps
326	Repeated actions	The action steps of the same axis are combined	Decompose the synchronous action steps
327	Only call in level one	None	None
328	Detect condition when acting	Steps of condition and action are combined	Discompose steps of condition and action
329	Clip/suck detection param	The parameters of fixture and main board are inconsistent	Please contact our technicians
330	Posture is chosen, please restart	Fixture definition is changed in Function - Product setting page	Restart
331	Posture selection param is wrong	Internal profile posture parameters are inconsistent with the host	Save in other definitions in Function-Mechanical param-Struct
332	Output chosen, please restart	Output definition in Function-Mechanical param-Struct is changed	Restart
333	Axis definition is changed, please restart	Axis definition in Function-Mechanical param-Struct is changed	Restart
334	Macro param checksum is wrong	Param in manual controller and host are inconsistent	Save structure param in Function-Mechanical param
360	X2 axis param check	Param in manual controller and host are inconsistent	Save axis param in Function-Mechanical param
361	Y2 axis param check	Param in manual controller and host are inconsistent	Save axis param in Function-Mechanical param
362	A axis param check	Param in manual controller and host are inconsistent	Save axis param in Function-Mechanical param

363	B axis param check	Param in manual controller and host are inconsistent	Save axis param in Function-Mechanical param
364	C axis param check	Param in manual controller and host are inconsistent	Save axis param in Function-Mechanical param
365	Structure param check	Param in manual controller and host are inconsistent	Save structure param in Function-Mechanical param
400	Read X axis Param, error	Param in manual controller and host are inconsistent	Save axis param in Function-Mechanical param
401	Read Y axis Param, error	Param in manual controller and host are inconsistent	Save axis param in Function-Mechanical param
402	Read X axis Param, error	Param in manual controller and host are inconsistent	Save axis param in Function-Mechanical param
403	Param initialization, error	Param in manual controller and host are inconsistent	Save structure param in Function-Mechanical param
404	Mode initialization, error	Param in manual controller and host are inconsistent	Save structure param in Function-Mechanical param
405	Macro initialization, error	Param in manual controller and host are inconsistent	Save structure param in Function-Mechanical param
406	Function initialization, error	Param in manual controller and host are inconsistent	Save structure param in Function-Mechanical param
499	EU/EC board communication overtime	Main board cannot contact EU board	<ol style="list-style-type: none"> 1. Check the connection between main board and EU board 2. Check the line order between main board and EU board 3. Replace main board 4. Replace EU board
500	Lost contact with host	Main board cannot contact manual controller	<ol style="list-style-type: none"> 1. Check the connection between manual controller and the host 2. Replace main board 3. Replace manual controller
501	Abnormal I/O board communication	Main board cannot contact I/O board	<ol style="list-style-type: none"> 1. Check the connection between main board and I/O board 2. Check the line order between main board and I/O board 3. Replace main board 4. Replace I/O board
502	Output completed	Number of products is up to output set	<ol style="list-style-type: none"> 1. Clear to zero in Function-Product setting page 2. Set output as zero in Function-Product setting page if no longer used

503	Low pressure	No signal in air pressure detection	1. Check air pressure signal 2. Set as Not use in Function-Signal setting page if no longer used
504	Communication Watchdog	Abnormal communication between main board and I/O board	Check the connection between main board and I/O board
505	Program synchronization error	Program in manual controller is not consistent with the host	Reload mold number
506	Wait for signal, overtime	Wait for the mold opened signal, overtime	1. Check the mold opened signal 2. Set a longer time of waiting for mold opened in Function-Product setting page
507	Modify param in non-stop state	Modify function param in non-stop state	Switch to stop state
508	Abnormal Servo 1 Communication	Main board cannot contact servo board 1	1. Check network cable of servo board1 2. Replace the host
509	Abnormal Servo 2 Communication	Main board cannot contact servo board 2	1. Check network cable of servo board2 2. Replace the host
510	Abnormal Servo 3 Communication	Main board cannot contact servo board 3	1. Check network cable of servo board3 2. Replace the host
511	Abnormal EUIO communication	Main board cannot contact EUIO	1. Check the connection between main board and EU board 2. Check the line order between main board and EU board 3. Replace main board 4. Replace EU board
512	Slave PRODUCT_ID error	The version of slave is not consistent with the host	Upgrade slave version to match the host
530	Abnormal ZSIO board communication	Main board cannot contact ZSIO	1. Check the connection between main board and ZSIO board 2. Check the line order between main board and ZSIO board 3. Replace main board 4. Replace ZSIO board
531	Abnormal IO board 1 communication	Main board cannot contact IO board 1	1. Check the connection between main board and IO board 2. Check the line order between main board and IO board 3. Replace main board 4. Replace IO board
532	Abnormal IO board 2 communication	Main board cannot contact IO board 2	1. Check the connection between main board and IO board 2. Check the line order between main board and IO board 3. Replace main board 4. Replace IO board

533	Abnormal IO board 3 communication	Main board cannot contact IO board 3	<ol style="list-style-type: none"> 1. Check the connection between main board and IO board 2. Check the line order between main board and IO board 3. Replace main board 4. Replace IO board
534	Abnormal IO board 4 communication	Main board cannot contact IO board 4	<ol style="list-style-type: none"> 1. Check the connection between main board and IO board 2. Check the line order between main board and IO board 3. Replace main board 4. Replace IO board
535	Abnormal IO board 5 communication	Main board cannot contact IO board 5	<ol style="list-style-type: none"> 1. Check the connection between main board and IO board 2. Check the line order between main board and IO board 3. Replace main board 4. Replace IO board
536	Abnormal IO board 6 communication	Main board cannot contact IO board 6	<ol style="list-style-type: none"> 1. Check the connection between main board and IO board 2. Check the line order between main board and IO board 3. Replace main board 4. Replace IO board
537	Abnormal IO board 7 communication	Main board cannot contact IO board 7	<ol style="list-style-type: none"> 1. Check the connection between main board and IO board 2. Check the line order between main board and IO board 3. Replace main board 4. Replace IO board
538	Abnormal IO board 8 communication	Main board cannot contact IO board 8	<ol style="list-style-type: none"> 1. Check the connection between main board and IO board 2. Check the line order between main board and IO board 3. Replace main board 4. Replace IO board
539	Abnormal IO board 9 communication	Main board cannot contact IO board 9	<ol style="list-style-type: none"> 1. Check the connection between main board and IO board 2. Check the line order between main board and IO board 3. Replace main board 4. Replace IO board
540	Abnormal EU67/EC board communication	Main board cannot contact EU67/EC board	<ol style="list-style-type: none"> 1. Check the connection between main board and EU67 board 2. Check the line order between main board and EU67 board 3. Replace main board 4. Replace EU67 board
550	X1, X2 set beyond boundary	Distance between X1, X2 axis is shorter than drawing distance	Move axis position of X1 and X2 to make the distance is longer than drawing distance

580	X1 Port Alarm	None	None
581	Y1 Port Alarm	None	None
600	Z moves to external safe zone, internal safe zone on	When the manipulator is in the external safety zone, internal safety signal is still on (only in the condition of automatic detection)	1. Check Z external safety position setting in Function - Mechanical parameter 2. Check Z external safety zone switch
601	Z moves to external safe zone, external safe zone off	When the manipulator is in the internal safety zone, external safety signal is cut off (only in the condition of automatic detection)	1. Check Z external safety position setting in Function - Mechanical parameter 2. Check Z external safety zone switch
602	Z moves to internal safe zone, external safe zone on	When the manipulator is in the internal safety zone, external safety signal is still on (only in the condition of automatic detection)	1. Check Z external safety position setting in Function - Mechanical parameter 2. Check Z external safety zone switch
603	Z moves to internal safe zone, internal safe zone off	When the manipulator is in the internal safety zone, internal safety signal is cut off (only in the condition of automatic detection)	1. Check Z external safety position setting in Function - Mechanical parameter 2. Check Z external safety zone switch
604	Origin is light, Y is not in safety zone	When the main arm descends to detection position (parameters defined in Y safety zone), Y origin signal is still on	1. Check Y axis setting in Function - Mechanical parameter 2. Check Y origin switch
605	Origin is not light, Y is in safety zone	When the main arm is in safety zone, Y origin signal is off	Check main and auxiliary up limit
606	Origin is light, B is not in safety zone	None	None
607	Origin is not light, B is in safety zone	None	None
608	Origin is light, Y2 is not in safety zone	When the sub arm is in safety zone, Y origin signal is off	Check main and auxiliary up limit
700	Wait overtime for X043	Wait overtime for the signal	1. Check if the signal is normal 2. Increase wait limit time
701	Wait overtime for X044	Wait overtime for the signal	1. Check if the signal is normal 2. Increase wait limit time
702	Wait overtime for Fixture 1	Wait overtime for the signal	1. Check if the signal is normal 2. Increase wait limit time

703	Wait overtime for Fixture 2	Wait overtime for the signal	Waiting for the signal overtime
704	Wait overtime for Fixture 3	Wait overtime for the signal	Waiting for the signal overtime
705	Wait overtime for Fixture 4	Wait overtime for the signal	Waiting for the signal overtime
706	Wait overtime for Suction 1	Wait overtime for the signal	Waiting for the signal overtime
707	Wait overtime for Suction 2	Wait overtime for the signal	Waiting for the signal overtime
708	Wait overtime for thimble forward to position	Wait overtime for the signal	Waiting for the signal overtime
709	Wait overtime for thimble back to position	Wait overtime for the signal	Waiting for the signal overtime
710	Wait overtime for core in in position	Wait overtime for the signal	Waiting for the signal overtime
711	Wait overtime for core out in position	Wait overtime for the signal	Waiting for the signal overtime
712	Wait overtime for core in 2 in position	Wait overtime for the signal	Waiting for the signal overtime
713	Wait overtime for core out 2 in position	Wait overtime for the signal	Waiting for the signal overtime
714	Wait overtime for X045	Wait overtime for the signal	Waiting for the signal overtime
715	Wait overtime for X046	Wait overtime for the signal	Waiting for the signal overtime
716	Wait overtime for X047	Wait overtime for the signal	Waiting for the signal overtime
717	Wait overtime for X026	Wait overtime for the signal	Waiting for the signal overtime
718	Wait overtime for X040	Wait overtime for the signal	Waiting for the signal overtime
719	Wait overtime for X023	Wait overtime for the signal	Waiting for the signal overtime
720	Wait overtime for X037	Wait overtime for the signal	Waiting for the signal overtime
721	Wait overtime for X017	Wait overtime for the signal	Waiting for the signal overtime
722	Wait overtime for X036	Wait overtime for the signal	Waiting for the signal overtime
1000	Mid-board signal is off while arm descending	1. When pneumatic sub arm falls, internal mid-board signal in rising limit is off. 2. When Y1 falls, mid-board signal outside Y1 safety zone or in other places except rising limit is off(except finding origin)	1. Check the mid-board signal. 2. If not use mid-board mold functions, please set mid-board mold as not use in Function-Signal.

1001	Mold opened signal is off while arm descending	1. When Y1 falls, mold opened signal outside Y1 safety zone or in other places except rising limit is off(except finding origin)	1. Check the mold opened signal 2. Check the steps of program
1002	Safety door is opened when arm descends.	1. When Y1 falls, safety door opens in automatic state outside Y1 safety zone or in other places except rising limit. 2. When pneumatic sub arm falls, safety door signal is not detected in internal sub arm rising limit. (except automatic step)	1. Check the safety door signal 2. Check the steps of program
1003	Vertical and horizontal signals are both on	Vertical and horizontal spacing limit have signals at the same time	Check the horizontal limit switch and vertical limit switch
1004	Z axis origin signal and external safety zone signal are both on	Z origin switch and external safety zone switch are on at the same time	Check Z origin switch and external safety zone switch
1005	Mold opened signal is off when Arm descends in the type	1. In internal area or other places except external area, main rising limit is off or sub rising limit is off, or Y1 is not in safety zone 2. Mold opened signal is off in auto state 3. When mold locked is allowed in other states, mold opened signal is off	1. Check the mold opened signal 2. Check the steps of program
1006	Posture 1 is wrong while descending internal	1. Press main arm descending button in manual state. Posture 1 vertical signal is not detected in internal safety area or other places except external safety area 2. In auto state, posture 1 vertical signal is not detected in internal safety area, other places except external safety area or other places except rising limit 3. Posture 1 vertical signal is not detected in internal safety area when pneumatic main arm descends	1. Check whether posture 1 is vertical 2. Check vertical limit switch
1007	Arm descends internal but not in Z axis internal safety zone	When Y1 falls, out of the Y1 internal safety area or in other places except rising limit, internal safety zone signal is detected but the position is not in the zone	1. Check whether the Z axis internal safety zone is set correct in Function-Mechanical param

1008	Arm descends external but not in Z axis external safety zone	When Y1 falls, out of the Y1 internal safety area or in other places except rising limit, external safety zone signal is detected but the position is not in the zone	1.Check whether the Z axis internal safety zone is set correct in Function-Mechanical param
1009	Do not detect safety zone signal when descending	When Y1 falls, out of the Y1 internal safety area or in other places except rising limit, internal/external safety zone signal is not detected	1.Check whether the descending position is in safety zone 2.Check Z origin switch and external safety zone switch
1010	Y1 is not in Z axis safety zone when descending	When Y1 falls, in other places except rising limit, internal/external safety zone signal is not detected	1.Check whether the descending position is in safety zone 2.Check Z origin switch and external safety zone switch
1011	Y1 is not in X axis safety zone when descending	When Y1 falls, in other places except rising limit, X axis safety zone signal is not detected	Check whether X axis is set correct in Function-Mechanical param
1012	Tow groups of profile posture are horizontal at the same time	Posture 1 and posture 2 are horizontal at the same time	1.Check whether posture 1 and posture 2 have horizontal action at the same time 2.Check switches of level limit 1 and level limit 2
1013	Sub forward/backward limit is both on	Sub forward/backward limit signal lamps are on at the same time	Check the sub forward/backward limit switch
1014	Sub up/down limit is both on	Sub up/down limit signal lamps are on at the same time	Check the sub up/down limit switch
1015	Main forward/backward limit is both on	Main forward/backward limit signal lamps are on at the same time	Check the main forward/backward limit switch
1016	Main up/down limit is both on	Main up/down limit signal lamps are on at the same time	Check the main up/down limit switch
1017	Safety door opens when running	Safety door opens when running automatically	1.Check whether the safety door is opened 2.Check the safety door signal
1018	Y2 is not in X2 axis safety zone when descending	When Y2 falls, in other places except rising limit, X2 axis safety zone signal is not detected	Check whether X2 axis is set correct in Function-Mechanical param

1019	The mold opened signal is off when origin is reset	Mold opened signal is off when the origin is reset	<ol style="list-style-type: none"> 1. Check signal setting in Function 2. If checking mold opened as no use in finding origin, the system will alarm once when mold opened signal is off, and it can continue finding origin after removing the alarm
1020	The mid-mold signal is off when origin is reset	Mid-mold signal is off when the origin is reset	<ol style="list-style-type: none"> 1. Check mid-mold signal 2. Check No use of mid-mold in Function-Signal setting if no need of this function
1021	The posture is not vertical when origin is reset	The vertical limit has no signal when the origin is reset	<ol style="list-style-type: none"> 1. Check relative limit switches 2. Check No limit of reset posture in Function-Signal setting if no need of this function
1022	The posture is not horizontal when origin is reset	The horizontal limit has no signal when the origin is reset	
1023	The posture is not vertical in transverse movement	The vertical limit has no signal in transverse movement	<ol style="list-style-type: none"> 1. Check relative limit switches 2. Check No limit of transverse posture in Function-Signal setting if no need of this function
1024	The posture is not horizontal in transverse movement	The horizontal limit has no signal in transverse movement	
1025	Posture 2 is wrong while descending internal	<ol style="list-style-type: none"> 1. Press main arm descending button in manual state. Posture 2 vertical signal is not detected in internal safety area or other places except external safety area 2. In auto state, posture 2 vertical signal is not detected in internal safety area, other places except external safety area or other places except rising limit 3. Posture 2 vertical signal is not detected in internal safety area when pneumatic main arm descends 	<ol style="list-style-type: none"> 1. Check whether posture 2 is vertical 2. Check vertical limit switch

1026	Horizontal 2 limit and vertical 2 limit are both on	Horizontal 2 limit and vertical 2 limit have signal at the same time	Check vertical limit switch and horizontal limit switch
1027	Mold locked is not finished	Mold closed signal is not detected	1. Check mold closed signal 2. Check No use of mold locked in Function-Signal setting if no need of this function
1028	Trouble shooting	None	None
1029	No fully automatic signal	Automatic signal is off	Send the automatic signal
1030	Posture 2 is not vertical in transverse movement	Vertical 2 signal is off when the Z axis is moving transversely	Send a vertical 2 signal
1031	Posture 2 is not horizontal in transverse movement	Horizontal 2 signal is off when the Z axis is moving transversely	Send a horizontal 2 signal
1038	Z axis is not in external area in Reject	Z axis is not in external area in Reject period	Check whether the Z axis is set correct
1039	Z axis is not in external area in Reject	Z axis is not in external area in Reject period	Check whether the Z axis is set correct
1040	Previous action is not Z axis	Reject enable is checked	Remove the check or teach an Z axis before
1052	Spinning in, spinning out and main rising limit signals are off	x24, x25, x35, x32 signals are off	Check main/sub rising limit
1054	No X axis but has X action	Axis is not in Function - Mechanical parameters - Axis definition, but there is an action in mold number program	Delete axis action that is not defined
1055	No Y axis but has Y action	Axis is not in Function - Mechanical parameters - Axis definition, but there is an action in mold number program	Delete axis action that is not defined
1056	No Z axis but has Z action	Axis is not in Function - Mechanical parameters - Axis definition, but there is an action in mold number program	Delete axis action that is not defined
1057	No X2 axis but has X2 action	Axis is not in Function - Mechanical parameters - Axis definition, but there is an action in mold number program	Delete axis action that is not defined
1058	No Y2 axis but has Y2 action	Axis is not in Function - Mechanical parameters - Axis definition, but there is an action in mold number program	Delete axis action that is not defined

1059	No A axis but has A action	Axis is not in Function - Mechanical parameters - Axis definition , but there is an action in mold number program	Delete axis action that is not defined
1060	No B axis but has B action	Axis is not in Function - Mechanical parameters - Axis definition , but there is an action in mold number program	Delete axis action that is not defined
1061	No C axis but has C action	Axis is not in Function - Mechanical parameters - Axis definition , but there is an action in mold number program	Delete axis action that is not defined
1062	Sequence of X1 axis back to origin is set repeatedly	Function - Mechanical parameters - Structure - Other definitions, choose multiple X1 axes for sequence of X1 axis back to origin	Delete redundant X1 axes in sequence of returning
1063	Sequence of Y1 axis back to origin is set repeatedly	Function - Mechanical parameters - Structure - Other definitions, choose multiple Y1 axes for sequence of axis back to origin	Delete redundant Y1 axes in sequence of returning
1064	Sequence of Z axis back to origin is set repeatedly	Function - Mechanical parameters - Structure - Other definitions, choose multiple Z axes for sequence of axis back to origin	Delete redundant Z axes in sequence of returning
1065	Sequence of X2 axis back to origin is set repeatedly	Function - Mechanical parameters - Structure - Other definitions, choose multiple X2 axes for sequence of axis back to origin	Delete redundant X2 axes in sequence of returning
1066	Sequence of Y2 axis back to origin is set repeatedly	Function - Mechanical parameters - Structure - Other definitions, choose multiple Y2 axes for sequence of axis back to origin	Delete redundant Y2 axes in sequence of returning
1067	Sequence of A axis back to origin is set repeatedly	Function - Mechanical parameters - Structure - Other definitions, choose multiple A axes for sequence of axis back to origin	Delete redundant A axes in sequence of returning
1068	Sequence of B axis back to origin is set repeatedly	Function - Mechanical parameters - Structure - Other definitions, choose multiple B axes for sequence of axis back to origin	Delete redundant B axes in sequence of returning
1069	Sequence of C axis back to origin is set repeatedly	Function - Mechanical parameters - Structure - Other definitions, choose multiple C axes for sequence of axis back to origin	Delete redundant C axes in sequence of returning
1070	Use returning in order but order of X1 axis is not set	Function - Mechanical parameters - Structure - Other definitions, not choose X1 axis	Choose X1 axis in sequence of returning

1071	Use returning in order but order of Y1 axis is not set	Function - Mechanical parameters - Structure - Other definitions, not choose Y1 axis	Choose X2 axis in sequence of returning
1072	Use returning in order but order of Z axis is not set	Function - Mechanical parameters - Structure - Other definitions, not choose Z axis	Choose Y1 axis in sequence of returning
1073	Use returning in order but order of X2 axis is not set	Function - Mechanical parameters - Structure - Other definitions, not choose X2 axis	Choose Y2 axis in sequence of returning
1074	Use returning in order but order of Y2 axis is not set	Function - Mechanical parameters - Structure - Other definitions, not choose Y2 axis	Choose X1 axis in sequence of returning
1075	Use returning in order but order of A axis is not set	Function - Mechanical parameters - Structure - Other definitions, not choose A axis	Choose A axis in sequence of returning
1076	Use returning in order but order of B axis is not set	Function - Mechanical parameters - Structure - Other definitions, not choose B axis	Choose B axis in sequence of returning
1077	Use returning in order but order of C axis is not set	Function - Mechanical parameters - Structure - Other definitions, not choose C axis	Choose C axis in sequence of returning
1078	No main up limit signal when X2 axis returns to origin point	No X35 signal when back to the origin	Check whether main/sub up limit is normal
1079	No sub up limit signal when X2 axis returns to origin point	No X32 signal when back to the origin	Check whether main/sub up limit is normal
1080	No main up limit signal when Z axis returns to origin point	No X35 signal when back to the origin	Check whether main/sub up limit is normal
1081	No sub up limit signal when Z axis returns to origin point	No X32 signal when back to the origin	Check whether main/sub up limit is normal
1100	Safety zone is not detected when the main arm descends	When pneumatic main arm descends, internal/external safety zone signal is not detected	1. Check Z origin switch and external safety zone switch 2. Check whether the steps of program are correct
1101	Safety zone is not detected when the sub arm descends	When pneumatic sub arm descends, internal/external safety zone signal is not detected	1. Check Z origin switch and external safety zone switch 2. Check whether the steps of program are correct
1102	Mold-opened signal is off when main arm descends	When pneumatic main arm descends, mold opened signal is not detected in internal safety zone	Check mold opened signal

1103	Mold-opened signal is off when sub arm descends	When pneumatic sub arm descends, mold opened signal is not detected in internal safety zone	Check mold opened signal
1104	Main up limit is on after main arm descended	After pneumatic main arm descends, main up limit switch has signal	1. Check whether the main arm descends 2. Check main up limit switch
1105	Sub up limit is on after sub arm descended	After pneumatic sub arm descends, sub up limit switch has signal	1. Check whether the sub arm descends 2. Check sub up limit switch
1106	Descending limit is off after main arm descends	After pneumatic main arm descends, main down limit has no signal	1. Check whether the main arm descends 2. Check main down limit switch 3. Choose No use of Main down limit in Function-Mechanical param-Structure if there is no descending limit
1107	Descending limit is off after sub arm descends	After pneumatic sub arm descends, sub down limit has no signal	1. Check whether the sub arm descends 2. Check sub down limit switch 3. Choose No use of Main down limit in Function-Mechanical param-Structure if there is no descending limit
1108	Mid-mold signal is off when main arm descends	Mid-mold signal is off when pneumatic main arm is descending	1. Check mid-mold signal 2. Check No use of mid-mold in Function-Signal setting if no need of this function
1109	Mid-mold signal is off when sub arm descends	Mid-mold signal is off when pneumatic sub arm is descending	1. Check mid-mold signal 2. Check No use of mid-mold in Function-Signal setting if no need of this function
1120	When main arm is rising, internal/external safety zone signal is not detected	When pneumatic main arm is rising, Z origin and external safety zone have no signal	Check Z origin switch and external safety zone switch
1121	When sub arm is rising, internal/external safety zone signal is not detected	When pneumatic main arm is rising, Z origin and external safety zone have no signal	
1122	Main arm rises too fast	When pneumatic main arm is rising, main up limit signal can be detected for a while after the main down valve is closed	Check whether the main up limit is normally on

1123	Sub arm rises too fast	When pneumatic sub arm is rising, sub up limit signal can be detected for a while after the main down valve is closed	Check whether the sub up limit is normally on
1124	Mold-opened signal is off when Main Arm rises	Mold opened signal is off when pneumatic main arm is rising	Check the mold opened signal
1125	Mold-opened signal is off when sub arm rises	Mold opened signal is off when pneumatic sub arm is rising	
1126	Main up limit is off after main arm rises	After pneumatic main arm rises, main up limit has no signal	1.Check whether the main arm rises 2.Check main up limit switch
1127	Sub up limit is off after sub arm rises	After pneumatic sub arm rises, sub up limit has no signal	1.Check whether the sub arm rises 2.Check sub up limit switch
1140	Main backward limit is on after main arm moves forward	Main backward limit has signal after pneumatic main arm moves forward	1. Check whether the main arm moves forward 2. Check main backward limit switch 3. Choose No use of Main backward limit in Function-Mechanical param-Structure if there is no main backward limit
1141	Sub backward limit is on after sub arm moves forward	Sub backward limit has signal after pneumatic sub arm moves forward	1. Check whether the sub arm moves forward 2. Check sub backward limit switch 3. Choose No use of Sub backward limit in Function-Mechanical param-Structure if there is no sub backward limit
1142	Main backward limit is off after main arm moves backward	Main backward limit has no signal after pneumatic main arm moves backward	1. Check whether the main arm moves backward 2. Check main backward limit switch 3. Choose No use of Main backward limit in Function-Mechanical param-Structure if there is no main backward limit
1143	Sub backward limit is off after sub arm moves backward	Sub backward limit has no signal after pneumatic sub arm moves backward	1. Check whether the sub arm moves backward 2. Check sub backward limit switch 3. Choose No use of Sub backward limit in Function-Mechanical param-Structure if there is no sub backward limit

1144	Main forward limit is off after main arm moves forward	Main forward limit has no signal after pneumatic main arm moves forward	<ol style="list-style-type: none"> 1. Check whether the main arm moves forward 2. Check main forward limit switch 3. Choose No use of Main forward limit in Function-Mechanical param-Structure if there is no main forward limit
1145	Sub forward limit is off after sub arm moves forward	Sub forward limit has no signal after pneumatic sub arm moves forward	<ol style="list-style-type: none"> 1. Check whether the sub arm moves forward 2. Check sub forward limit switch 3. Choose No use of sub forward limit in Function-Mechanical param-Structure if there is no sub forward limit
1146	Main forward limit is on after main arm moves backward	Main forward limit has signal after pneumatic main arm moves backward	<ol style="list-style-type: none"> 1. Check whether the main arm moves backward 2. Check main forward limit switch 3. Choose No use of main forward limit in Function-Mechanical param-Structure if there is no main forward limit
1147	Sub forward limit is on after sub arm moves backward	Sub forward limit has signal after pneumatic sub arm moves backward	<ol style="list-style-type: none"> 1. Check whether the sub arm moves backward 2. Check sub forward limit switch 3. Choose No use of sub forward limit in Function-Mechanical param-Structure if there is no sub forward limit
1160	Main up limit signal is not detected when Posture 1 changes	<ol style="list-style-type: none"> 1. In internal safety zone, Posture 1 is vertical when main up limit signal is off 2. Not in external safety zone, Posture 1 is vertical/horizontal when main up limit signal is off 3. Z position is less than value set of Z internal safety zone. Posture 1 is vertical/horizontal when main up limit signal is off 	Check main up limit switch

1161	Sub up limit signal is not detected when Posture 1 changes	1. In internal safety zone, Posture 1 is vertical when sub up limit signal is off 2. Not in external safety zone, Posture 1 is vertical/horizontal when sub up limit signal is off 3. Z position is less than value set of Z internal safety zone. Posture 1 is vertical/horizontal when sub up limit signal is off	Check sub up limit switch
1162	Mold-opened signal is off when Posture 1 changes	Posture 1 is vertical in internal safety zone. Mold opened signal is off when selecting external standby or horizontal standby	Check mold opened signal
1163	Horizontal 1 limit is off after Posture 1 is horizontal	Horizontal 1 limit switch has no signal after Posture 1 is horizontal	1. Check whether Posture 1 is horizontal 2. Check horizontal 1 limit switch
1164	Vertical 1 limit is off after Posture 1 is vertical	Vertical 1 limit switch has no signal after Posture 1 is vertical	1. Check whether Posture 1 is vertical 2. Check vertical 1 limit switch
1165	Not in safety zone when posture is horizontal	Not in Z origin or external safety zone when posture is horizontal	1. Check Z origin switch and external safety zone switch 2. Check whether steps of program are correct
1170	Main up limit signal is not detected when Posture 2 changes	1. In internal safety zone, Posture 2 is vertical when main up limit signal is off 2. Not in external safety zone, Posture 2 is vertical/horizontal when main up limit signal is off 3. Z position is less than value set of Z internal safety zone. Posture 2 is vertical/horizontal when main up limit signal is off	Check main up limit switch
1171	Sub up limit signal is not detected when Posture 2 changes	1. In internal safety zone, Posture 2 is vertical when sub up limit signal is off 2. Not in external safety zone, Posture 2 is vertical/horizontal when sub up limit signal is off 3. Z position is less than value set of Z internal safety zone. Posture 2 is vertical/horizontal when sub up limit signal is off	Check sub up limit switch

1172	Mold-opened signal is off when Posture 2 changes	Posture 2 is vertical in internal safety zone. Mold opened signal is off when selecting external standby or horizontal standby	Check mold opened signal
1173	Horizontal 2 limit is off after Posture 2 is horizontal	Horizontal 2 limit switch has no signal after Posture 2 is horizontal	1. Check whether Posture 2 is horizontal 2. Check horizontal 2 limit switch
1174	Vertical 2 limit is off after Posture 2 is vertical	Vertical 2 limit switch has no signal after Posture 2 is vertical	1. Check whether Posture 2 is vertical 2. Check vertical 2 limit switch
1180	Main up limit is off during pneumatic transverse in/out	Main up limit point has no signal during pneumatic transverse in/out	Check main up limit
1181	Sub up limit is off during pneumatic transverse in/out	Sub up limit point has no signal during pneumatic transverse in/out	Check sub up limit
1182	Spin in limit is off after spin in	Spin in limit has no signal after pneumatic transverse entry	1. Check whether transverse entry is carried out 2. Check spin in limit switch
1183	Spin out limit is off after spinning out	Spin out limit has no signal after pneumatic transverse exit	1. Check whether transverse exit is carried out 2. Check spin out limit switch
1184	The posture is not the same with the instruction when spinning out	The posture of fixture is not the same as taught after spinning out	Check whether the fixture is loose
1185	Mold-opened signal is off when spinning in	When transverse entry Z decreases in external standby, mold opened signal is off out of external safety zone or position of Z is less than external safety area.	Check whether mold opened signal is normal
1186	Main up limit is off during transverse movement out of safety zone	When not in internal/external safety zone, or Z does transverse movement between internal and external area that has been set, main up limit is not detected	Check whether main up limit is normal
1187	Sub up limit is off during transverse movement out of safety zone	When not in internal/external safety zone, or Z does transverse movement between internal and external area that has been set, sub up limit is not detected	Check whether sub up limit is normal

1188	Y1 is not in safety zone during transverse movement out of safety zone	When not in internal/external safety zone, or Z does transverse movement between internal and external area that has been set, position of Y1 is larger than internal safety zone.	Check setting of Y axis in Function-Mechanical param
1189	Spin in from external place when main/sub up limit are not both on	Main/sub up limit are not both on when Z moves. The current position is larger than internal safety area while target position is less than it.	Check whether main/sub up limit is normal
1190	Spin out of internal place when main/sub up limit are not both on	Main/sub up limit are not both on when Z moves. The current position is less than internal safety area while target position is larger than it.	Check whether main/sub up limit is normal
1191	Rising limit is not detected during manual transverse movement out of safety area	Main/sub up limit are not both on or position of Y1 is larger than internal safety zone during manual transverse movement out of safety area	1. Check whether main/sub up limit is normal 2. This alarm occurs if Y axis standby position is 0 or distance per rotation is 0
1192	Current position is less than safety area allowed move to	The current position is less than safety area allowed move to during manual transverse entry	Check setting of Z axis in Function-Mechanical param
1193	Current position is larger than safety area allowed move to	The current position is larger than safety area allowed move to during manual transverse entry	Check setting of Z axis in Function-Mechanical param
1194	Y2 axis is not in rising position	When not in internal/external safety zone, or Z does transverse movement between internal and external area that has been set, position of Y1 is larger than internal safety zone.	Check setting of Y2 axis in Function-Mechanical param
1195	Wait overtime for Y1, Y2 up limit signals in transverse movement	Wait overtime for signals	Check whether main/sub up limit is normal
1200	Clip 1 valve signal is on; Clip 1 confirm signal is off	1. The valve acts when relative limit has no signal 2. The valve does not act when relative limit has signal	Check whether the valve and limit point are normal

1201	Clip 1 valve signal is off; Clip 1 confirm signal is on	1. The valve acts when relative limit has no signal 2. The valve does not act when relative limit has signal	Check whether the valve and limit point are normal
1202	Clip 2 valve signal is on; Clip 2 confirm signal is off	1. The valve acts when relative limit has no signal 2. The valve does not act when relative limit has signal	Check whether the valve and limit point are normal
1203	Clip 2 valve signal is off; Clip 2 confirm signal is on	1. The valve acts when relative limit has no signal 2. The valve does not act when relative limit has signal	Check whether the valve and limit point are normal
1204	Clip 3 valve signal is on; Clip 3 confirm signal is off	1. The valve acts when relative limit has no signal 2. The valve does not act when relative limit has signal	Check whether the valve and limit point are normal
1205	Clip 3 valve signal is off; Clip 3 confirm signal is on	1. The valve acts when relative limit has no signal 2. The valve does not act when relative limit has signal	Check whether the valve and limit point are normal
1206	Clip 4 valve signal is on; Clip 4 confirm signal is off	1. The valve acts when relative limit has no signal 2. The valve does not act when relative limit has signal	Check whether the valve and limit point are normal
1207	Clip 4 valve signal is off; Clip 4 confirm signal is on	1. The valve acts when relative limit has no signal 2. The valve does not act when relative limit has signal	Check whether the valve and limit point are normal
1208	Suck 1 valve signal is on; Suck 1 confirm signal is off	1. The valve acts when relative limit has no signal 2. The valve does not act when relative limit has signal	Check whether the valve and limit point are normal
1209	Suck 1 valve signal is off; Suck 1 confirm signal is on	1. The valve acts when relative limit has no signal 2. The valve does not act when relative limit has signal	Check whether the valve and limit point are normal
1210	Suck 2 valve signal is on; Suck 2 confirm signal is off	1. The valve acts when relative limit has no signal 2. The valve does not act when relative limit has signal	Check whether the valve and limit point are normal

1211	Suck 2 valve signal is off; Suck 2 confirm signal is on	1. The valve acts when relative limit has no signal 2. The valve does not act when relative limit has signal	Check whether the valve and limit point are normal
1212	Clip 7 valve signal is on; Clip 7 confirm signal is off	1. The valve acts when relative limit has no signal 2. The valve does not act when relative limit has signal	Check whether the valve and limit point are normal
1213	Clip 7 valve signal is off; Suck 12 confirm signal is on	1. The valve acts when relative limit has no signal 2. The valve does not act when relative limit has signal	Check whether the valve and limit point are normal
1214	Clip 8 valve signal is on; Clip 8 confirm signal is off	1. The valve acts when relative limit has no signal 2. The valve does not act when relative limit has signal	Check whether the valve and limit point are normal
1215	Clip 8 valve signal is off; Clip 8 confirm signal is on	1. The valve acts when relative limit has no signal 2. The valve does not act when relative limit has signal	Check whether the valve and limit point are normal
1216	Suck 5 valve signal is on; Suck 5 confirm signal is off	1. The valve acts when relative limit has no signal 2. The valve does not act when relative limit has signal	Check whether the valve and limit point are normal
1217	Suck 6 valve signal is off; Suck 6 confirm signal is on	1. The valve acts when relative limit has no signal 2. The valve does not act when relative limit has signal	Check whether the valve and limit point are normal
1218	Suck 7 valve signal is on; Suck 7 confirm signal is off	1. The valve acts when relative limit has no signal 2. The valve does not act when relative limit has signal	Check whether the valve and limit point are normal
1219	Suck 8 valve signal is off; Suck 8 confirm signal is on	1. The valve acts when relative limit has no signal 2. The valve does not act when relative limit has signal	Check whether the valve and limit point are normal
1220	Suck 9 valve signal is on; Suck 9 confirm signal is off	1. The valve acts when relative limit has no signal 2. The valve does not act when relative limit has signal	Check whether the valve and limit point are normal
1221	Suck 10 valve signal is off; Suck 10 confirm signal is on	1. The valve acts when relative limit has no signal 2. The valve does not act when relative limit has signal	Check whether the valve and limit point are normal
1222	Suck 11 valve signal is on; Suck 11 confirm signal is off	1. The valve acts when relative limit has no signal 2. The valve does not act when relative limit has signal	Check whether the valve and limit point are normal

1223	Suck 12 valve signal is off; Suck 12 confirm signal is on	1.The valve acts when relative limit has no signal 2.The valve does not act when relative limit has signal	Check whether the valve and limit point are normal
1250	X037 signal is not detected	Wait overtime for signal	1.Check whether the signal waiting for is normal 2.Set a longer wait limit time
1251	X023 signal is not detected	Wait overtime for signal	1.Check whether the signal waiting for is normal 2.Set a longer wait limit time
1300	Check standby point posture	Standby posture error	Check vertical/horizontal limit
1301	Check standby point main arm up limit	1.Position of standby point is larger than the max Y1 axis standby position 2.Main arm is not in Y1 origin and cannot do transverse movement when returning to standby point	1.Check whether Y1 axis is set correct in Function-Mechanical param 2.Manually move Y1 axis to origin point
1302	Check standby point sub arm up limit	1.Position of standby point is larger than the max Y2 axis standby position 2.Main arm is not in Y2 origin and cannot do transverse movement when returning to standby point	1.Check whether Y2 axis is set correct in Function-Mechanical param 2.Manually move Y2 axis to origin point
1303	Check standby point X position	When teaching, suck/clip action signal of standby point is off by default. Insert Clip ON action into step0 standby position if needed. System will return to standby point automatically after a cycle, except for clip/suck actions. If clip signal is off in standby point, but it is on after a cycle ended, the alarm will occur; If clip signal is on in standby point, but it is off after a cycle, the alarm will also occur. Internal insert teaching begins from the upper horizontal part of the arm. Steps are fetching inserts, transverse entry, waiting for mold opened, moving downward and embedding, fetching product, moving upward and allowing mold locked, crossing out and placing, moving upward. According to these steps, clip/suck signal in standby point is off, so it is when the cycle ends.	

1304	Check standby point Y position	<p>When teaching, suck/clip action signal of standby point is off by default. Insert Clip ON action into step1 standby position if needed.</p> <p>System will return to standby point automatically after a cycle, except for clip/suck actions.</p> <p>If clip signal is off in standby point, but it is on after a cycle ended, the alarm will occur;</p> <p>If clip signal is on in standby point, but it is off after a cycle, the alarm will also occur.</p> <p>Internal insert teaching begins from the upper horizontal part of the arm. Steps are fetching inserts, transverse entry, waiting for mold opened, moving downward and embedding, fetching product, moving upward and allowing mold locked, crossing out and placing, moving upward. According to these steps, clip/suck signal in standby point is off, so it is when the cycle ends.</p>
1305	Check standby point Z position	<p>When teaching, suck/clip action signal of standby point is off by default. Insert Clip ON action into step2 standby position if needed.</p> <p>System will return to standby point automatically after a cycle, except for clip/suck actions.</p> <p>If clip signal is off in standby point, but it is on after a cycle ended, the alarm will occur;</p> <p>If clip signal is on in standby point, but it is off after a cycle, the alarm will also occur.</p> <p>Internal insert teaching begins from the upper horizontal part of the arm. Steps are fetching inserts, transverse entry, waiting for mold opened, moving downward and embedding, fetching product, moving upward and allowing mold locked, crossing out and placing, moving upward. According to these steps, clip/suck signal in standby point is off, so it is when the cycle ends.</p>
1306	Check standby point Clip1	<p>When teaching, suck/clip action signal of standby point is off by default. Insert Clip ON action into step3 standby position if needed.</p> <p>System will return to standby point automatically after a cycle, except for clip/suck actions.</p> <p>If clip signal is off in standby point, but it is on after a cycle ended, the alarm will occur;</p> <p>If clip signal is on in standby point, but it is off after a cycle, the alarm will also occur.</p> <p>Internal insert teaching begins from the upper horizontal part of the arm. Steps are fetching inserts, transverse entry, waiting for mold opened, moving downward and embedding, fetching product, moving upward and allowing mold locked, crossing out and placing, moving upward. According to these steps, clip/suck signal in standby point is off, so it is when the cycle ends.</p>

1307	Check standby point Clip2	<p>When teaching, suck/clip action signal of standby point is off by default. Insert Clip ON action into step4 standby position if needed.</p> <p>System will return to standby point automatically after a cycle, except for clip/suck actions.</p> <p>If clip signal is off in standby point, but it is on after a cycle ended, the alarm will occur;</p> <p>If clip signal is on in standby point, but it is off after a cycle, the alarm will also occur.</p> <p>Internal insert teaching begins from the upper horizontal part of the arm. Steps are fetching inserts, transverse entry, waiting for mold opened, moving downward and embedding, fetching product, moving upward and allowing mold locked, crossing out and placing, moving upward. According to these steps, clip/suck signal in standby point is off, so it is when the cycle ends.</p>
1308	Check standby point Clip3	<p>When teaching, suck/clip action signal of standby point is off by default. Insert Clip ON action into step5 standby position if needed.</p> <p>System will return to standby point automatically after a cycle, except for clip/suck actions.</p> <p>If clip signal is off in standby point, but it is on after a cycle ended, the alarm will occur;</p> <p>If clip signal is on in standby point, but it is off after a cycle, the alarm will also occur.</p> <p>Internal insert teaching begins from the upper horizontal part of the arm. Steps are fetching inserts, transverse entry, waiting for mold opened, moving downward and embedding, fetching product, moving upward and allowing mold locked, crossing out and placing, moving upward. According to these steps, clip/suck signal in standby point is off, so it is when the cycle ends.</p>
1309	Check standby point Clip4	<p>When teaching, suck/clip action signal of standby point is off by default. Insert Clip ON action into step6 standby position if needed.</p> <p>System will return to standby point automatically after a cycle, except for clip/suck actions.</p> <p>If clip signal is off in standby point, but it is on after a cycle ended, the alarm will occur;</p> <p>If clip signal is on in standby point, but it is off after a cycle, the alarm will also occur.</p> <p>Internal insert teaching begins from the upper horizontal part of the arm. Steps are fetching inserts, transverse entry, waiting for mold opened, moving downward and embedding, fetching product, moving upward and allowing mold locked, crossing out and placing, moving upward. According to these steps, clip/suck signal in standby point is off, so it is when the cycle ends.</p>

1310	Check standby point Suck1	<p>When teaching, suck/clip action signal of standby point is off by default. Insert Clip ON action into step7 standby position if needed.</p> <p>System will return to standby point automatically after a cycle, except for clip/suck actions.</p> <p>If clip signal is off in standby point, but it is on after a cycle ended, the alarm will occur;</p> <p>If clip signal is on in standby point, but it is off after a cycle, the alarm will also occur.</p> <p>Internal insert teaching begins from the upper horizontal part of the arm. Steps are fetching inserts, transverse entry, waiting for mold opened, moving downward and embedding, fetching product, moving upward and allowing mold locked, crossing out and placing, moving upward. According to these steps, clip/suck signal in standby point is off, so it is when the cycle ends.</p>
1311	Check standby point Suck2	<p>When teaching, suck/clip action signal of standby point is off by default. Insert Clip ON action into step8 standby position if needed.</p> <p>System will return to standby point automatically after a cycle, except for clip/suck actions.</p> <p>If clip signal is off in standby point, but it is on after a cycle ended, the alarm will occur;</p> <p>If clip signal is on in standby point, but it is off after a cycle, the alarm will also occur.</p> <p>Internal insert teaching begins from the upper horizontal part of the arm. Steps are fetching inserts, transverse entry, waiting for mold opened, moving downward and embedding, fetching product, moving upward and allowing mold locked, crossing out and placing, moving upward. According to these steps, clip/suck signal in standby point is off, so it is when the cycle ends.</p>
1312	Check standby point A	<p>When teaching, suck/clip action signal of standby point is off by default. Insert Clip ON action into step9 standby position if needed.</p> <p>System will return to standby point automatically after a cycle, except for clip/suck actions.</p> <p>If clip signal is off in standby point, but it is on after a cycle ended, the alarm will occur;</p> <p>If clip signal is on in standby point, but it is off after a cycle, the alarm will also occur.</p> <p>Internal insert teaching begins from the upper horizontal part of the arm. Steps are fetching inserts, transverse entry, waiting for mold opened, moving downward and embedding, fetching product, moving upward and allowing mold locked, crossing out and placing, moving upward. According to these steps, clip/suck signal in standby point is off, so it is when the cycle ends.</p>

1313	Check standby point B	<p>When teaching, suck/clip action signal of standby point is off by default. Insert Clip ON action into step10 standby position if needed.</p> <p>System will return to standby point automatically after a cycle, except for clip/suck actions.</p> <p>If clip signal is off in standby point, but it is on after a cycle ended, the alarm will occur;</p> <p>If clip signal is on in standby point, but it is off after a cycle, the alarm will also occur.</p> <p>Internal insert teaching begins from the upper horizontal part of the arm. Steps are fetching inserts, transverse entry, waiting for mold opened, moving downward and embedding, fetching product, moving upward and allowing mold locked, crossing out and placing, moving upward. According to these steps, clip/suck signal in standby point is off, so it is when the cycle ends.</p>
1314	Check standby point C	<p>When teaching, suck/clip action signal of standby point is off by default. Insert Clip ON action into step11 standby position if needed.</p> <p>System will return to standby point automatically after a cycle, except for clip/suck actions.</p> <p>If clip signal is off in standby point, but it is on after a cycle ended, the alarm will occur;</p> <p>If clip signal is on in standby point, but it is off after a cycle, the alarm will also occur.</p> <p>Internal insert teaching begins from the upper horizontal part of the arm. Steps are fetching inserts, transverse entry, waiting for mold opened, moving downward and embedding, fetching product, moving upward and allowing mold locked, crossing out and placing, moving upward. According to these steps, clip/suck signal in standby point is off, so it is when the cycle ends.</p>
1315	Check standby point X2	<p>When teaching, suck/clip action signal of standby point is off by default. Insert Clip ON action into step12 standby position if needed.</p> <p>System will return to standby point automatically after a cycle, except for clip/suck actions.</p> <p>If clip signal is off in standby point, but it is on after a cycle ended, the alarm will occur;</p> <p>If clip signal is on in standby point, but it is off after a cycle, the alarm will also occur.</p> <p>Internal insert teaching begins from the upper horizontal part of the arm. Steps are fetching inserts, transverse entry, waiting for mold opened, moving downward and embedding, fetching product, moving upward and allowing mold locked, crossing out and placing, moving upward. According to these steps, clip/suck signal in standby point is off, so it is when the cycle ends.</p>

1316	Check standby point Y2	<p>When teaching, suck/clip action signal of standby point is off by default. Insert Clip ON action into step13 standby position if needed.</p> <p>System will return to standby point automatically after a cycle, except for clip/suck actions.</p> <p>If clip signal is off in standby point, but it is on after a cycle ended, the alarm will occur;</p> <p>If clip signal is on in standby point, but it is off after a cycle, the alarm will also occur.</p> <p>Internal insert teaching begins from the upper horizontal part of the arm. Steps are fetching inserts, transverse entry, waiting for mold opened, moving downward and embedding, fetching product, moving upward and allowing mold locked, crossing out and placing, moving upward. According to these steps, clip/suck signal in standby point is off, so it is when the cycle ends.</p>
1333	Check standby point suck3	<p>When teaching, suck/clip action signal of standby point is off by default. Insert Clip ON action into step14 standby position if needed.</p> <p>System will return to standby point automatically after a cycle, except for clip/suck actions.</p> <p>If clip signal is off in standby point, but it is on after a cycle ended, the alarm will occur;</p> <p>If clip signal is on in standby point, but it is off after a cycle, the alarm will also occur.</p> <p>Internal insert teaching begins from the upper horizontal part of the arm. Steps are fetching inserts, transverse entry, waiting for mold opened, moving downward and embedding, fetching product, moving upward and allowing mold locked, crossing out and placing, moving upward. According to these steps, clip/suck signal in standby point is off, so it is when the cycle ends.</p>
1334	Check standby point suck4	<p>When teaching, suck/clip action signal of standby point is off by default. Insert Clip ON action into step15 standby position if needed.</p> <p>System will return to standby point automatically after a cycle, except for clip/suck actions.</p> <p>If clip signal is off in standby point, but it is on after a cycle ended, the alarm will occur;</p> <p>If clip signal is on in standby point, but it is off after a cycle, the alarm will also occur.</p> <p>Internal insert teaching begins from the upper horizontal part of the arm. Steps are fetching inserts, transverse entry, waiting for mold opened, moving downward and embedding, fetching product, moving upward and allowing mold locked, crossing out and placing, moving upward. According to these steps, clip/suck signal in standby point is off, so it is when the cycle ends.</p>

1400	Do not detect rising	In auto mode, press the start key, system do return action and back to standby point. While reset, the main and sub arms must be on the up limit point, or it will alarm	<ol style="list-style-type: none"> 1. Check whether the auxiliary up limit is normal 2. Manually move the sub arm to the origin
1401	Not internal at the same time	When reset, the main and sub arms must be on the up limit point, or it will alarm	<ol style="list-style-type: none"> 1. Check whether the auxiliary up limit is normal 2. Manually move the sub arm to the origin
1402	Not external at the same time	When reset, the main and sub arms must be on the up limit point, or it will alarm	<ol style="list-style-type: none"> 1. Check whether the auxiliary up limit is normal 2. Manually move the sub arm to the origin
1403	Can not check the Y2 up limit	In auto mode, press the start key, system do return action and back to standby point. While reset, the main and sub arms must be on the up limit point, or it will alarm	<ol style="list-style-type: none"> 1. Check whether the auxiliary up limit is normal 2. Manually move the sub arm to the origin
1410	Wait overtime for external descending safety signal	Wait overtime for signal	<ol style="list-style-type: none"> 1. Check whether the signal waiting for is normal 2. Set a longer limit time of waiting
1411	Wait overtime for external descending safety signal	Wait overtime for signal	<ol style="list-style-type: none"> 1. Check whether the signal waiting for is normal 2. Set a longer limit time of waiting
1412	Error in relative position of shaft	The current running axis is inconsistent with the teaching axis	Check whether the taught axis deviation in waiting is correct
1420	Servo 1 off-line	Main board cannot contact servo board 1	Check that the wire of the servo board 1 is loose
1421	Servo 2 off-line	Main board cannot contact servo board 2	Check if the wire of the servo board 2 is loose
1422	Servo 3 off-line	Main board cannot contact servo board 3	Check if the wire of the servo plate 3 is loose
1423	Servo 4 off-line	Main board cannot contact servo board 4	Check if the wire of the servo panel 4 is loose

QCS3G Servo Alarm

Alarm Number	Alarm Information	Alarm Reason	Alarm Solution
3101	Emergency stop alarm	Servo has emergency stop signal input	1. Turn out the manual controller emergency stop knob 2. Make the host emergency stop signal short connected
3102	X axis overcurrent	IPM module over current protection	1. Whether the motor is locked 2. Pull out power line and brake line after power on again. If alarm, it is host failure and replace it; if not, check motor and wiring.
3203	Y axis overcurrent	IPM module over current protection	1. Whether the motor is locked 2. Pull out power line and brake line after power on again. If alarm, it is host failure and replace it; if not, check motor and wiring.
3302	Z axis overcurrent	IPM module over current protection	1. Whether the motor is locked 2. Pull out power line and brake line after power on again. If alarm, it is host failure and replace it; if not, check motor and wiring.
3105	X axis overload	Over the maximum load	1. Check the load 2. Whether the motor is shut off, whether the lock is loose 3. Check whether param1 is the corresponding power
3206	Y axis overload	Over the maximum load	1. Check the load 2. Whether the motor is shut off, whether the lock is loose 3. Check whether param1 is the corresponding power
3305	Z axis overload	Over the maximum load	1. Check the load 2. Whether the motor is shut off, whether the lock is loose 3. Check whether param1 is the corresponding power
3107	Initialization of X axis current sampling module failed	Drive power on initialization is not over	1. Press stop to clear 2. Power on again if can not clear 3. Host failure, replace it
3208	Initialization of Y axis current sampling module failed	Drive power on initialization is not over	1. Press stop to clear 2. Power on again if can not clear 3. Host failure, replace it
3307	Initialization of Z axis current sampling module failed	Drive power on initialization is not over	1. Press stop to clear 2. Power on again if can not clear 3. Host failure, replace it

3109	X axis UVW phase current abnormality	Current exceeds alarm value	<ol style="list-style-type: none"> 1.Cable sequence error 2.Lack of phase 3.The motor code does not correspond to the motor
3210	Y axis UVW phase current abnormality	Current exceeds alarm value	<ol style="list-style-type: none"> 1.Cable sequence error 2.Lack of phase 3.The motor code does not correspond to the motor
3309	Z axis UVW phase current abnormality	Current exceeds alarm value	<ol style="list-style-type: none"> 1.Cable sequence error 2.Lack of phase 3.The motor code does not correspond to the motor
3111	X axis DC undervoltage	Voltage detected above 195v	<ol style="list-style-type: none"> 1.The load is too heavy, the acceleration is too high, resulting in too much voltage drop 2.External power into the voltage is too low 3.Host failure, replace it
3211	Y axis DC undervoltage	Voltage detected above 195v	<ol style="list-style-type: none"> 1.The load is too heavy, the acceleration is too high, resulting in too much voltage drop 2.External power into the voltage is too low 3.Host failure, replace it
3311	Z axis DC undervoltage	Voltage detected above 195v	<ol style="list-style-type: none"> 1.The load is too heavy, the acceleration is too high, resulting in too much voltage drop 2.External power into the voltage is too low 3.Host failure, replace it
3112	X axis VDC overvoltage	Voltage detected above 405v	<ol style="list-style-type: none"> 1.The load is too heavy, the acceleration is too high, resulting in too much voltage drop 2.External power into the voltage is too low 3.Host failure, replace it
3212	Y axis VDC overvoltage	Voltage detected above 405v	<ol style="list-style-type: none"> 1.The load is too heavy, the acceleration is too high, resulting in too much voltage drop 2.External power into the voltage is too low 3.Host failure, replace it
3312	Z axis VDC overvoltage	Voltage detected above 405v	<ol style="list-style-type: none"> 1.The load is too heavy, the acceleration is too high, resulting in too much voltage drop 2.External power into the voltage is too low 3.Host failure, replace it

3113	X axis overspeed	Over max speed	<ol style="list-style-type: none"> 1. Internal communication drops, check whether the grounding is good 2. The parameter setting of 50 is wrong
3214	Y axis overspeed	Over max speed	<ol style="list-style-type: none"> 1. Internal communication drops, check whether the grounding is good 2. The parameter setting of 50 is wrong
3313	Z axis overspeed	Over max speed	<ol style="list-style-type: none"> 1. Internal communication drops, check whether the grounding is good 2. The parameter setting of 50 is wrong
3115	X axis drive overheat	The internal temperature exceeds 75 degrees	<ol style="list-style-type: none"> 1. Check if the fan is normal 2. Host failure, replace it
3116	X axis writes IIC fail	Memory chip anomaly	Mainframe replacement
3217	Y axis reads IIC fail	Memory chip anomaly	Mainframe replacement
3316	Z axis reads IIC fail	Memory chip anomaly	Mainframe replacement
3118	Excessive deviation of X axis position	Deviation between the command value and the actual encoder value exceeds the set value of param49	<ol style="list-style-type: none"> 1. Set 49 servo parameters, increase the deviation range 2. The acceleration and deceleration settings are too small 3. The system is abnormal
3219	Excessive deviation of Y axis position	Deviation between the command value and the actual encoder value exceeds the set value of param49	<ol style="list-style-type: none"> 1. Set 49 servo parameters, increase the deviation range 2. The acceleration and deceleration settings are too small 3. The system is abnormal
3318	Excessive deviation of Z axis position	Deviation between the command value and the actual encoder value exceeds the set value of param49	<ol style="list-style-type: none"> 1. Set 49 servo parameters, increase the deviation range 2. The acceleration and deceleration settings are too small 3. The system is abnormal
3120	X axis encoder error	Encoder communication failure	<ol style="list-style-type: none"> 1. Encoder line is abnormal 2. Poor contact at the junction of encoder 3. Motor encoder is abnormal
3320	Z axis encoder error	Encoder communication failure	<ol style="list-style-type: none"> 1. Encoder line is abnormal 2. Poor contact at the junction of encoder 3. Motor encoder is abnormal

3121	Abnormal X axis velocity measurement	Abnormal rotation of motor	<ol style="list-style-type: none"> 1. Motor code setting is wrong 2. The gain parameter is not reasonable 3. Motor fault causes chaotic rotation
3321	Abnormal Z axis velocity measurement	Abnormal rotation of motor	<ol style="list-style-type: none"> 1. Motor code setting is wrong 2. The gain parameter is not reasonable 3. Motor fault causes chaotic rotation
3122	X axis encoder initializing	Encoder initialization	<ol style="list-style-type: none"> 1. Encoder line is abnormal 2. Poor contact at the junction of encoder 3. Motor encoder is abnormal
3322	Z axis encoder initializing	Encoder initialization	<ol style="list-style-type: none"> 1. Encoder line is abnormal 2. Poor contact at the junction of encoder 3. Motor encoder is abnormal
3123	X axis hard over-pressure	Internal hardware over-voltage protection	<ol style="list-style-type: none"> 1. The load is too heavy, the deceleration is too high, resulting in too much voltage rise 2. Brake resistor failure or non-conductivity 3. Host failure. Replace
3124	X axis external Bus ERR	Normal signal from bus is not received	<ol style="list-style-type: none"> 1. Top 3-pin white terminal is loose 2. Host malfunction
3125	X axis buffer overflow	System abnormality	Replace the host
3226	Y axis buffer overflow	System abnormality	Replace the host
3227	EEPROM parameter check exception	Storage chip abnormality	Replace the host
3228	Y axis encoder error	Encoder communication failure	<ol style="list-style-type: none"> 1. Encoder line is abnormal 2. Poor contact at the junction of encoder 3. Motor encoder is abnormal
3229	Abnormal Y axis velocity measurement	Encoder feedback value is abnormal	<ol style="list-style-type: none"> 1. Motor code setting is wrong 2. The gain parameter is not reasonable 3. Motor fault causes chaotic rotation

3230	Y axis encoder initializing	Encoder initialization	<ol style="list-style-type: none"> 1.Encoder line is abnormal 2.Poor contact at the junction of encoder 3.Motor encoder is abnormal
3332	Servo driver alarm	The stored parameters are verified incorrectly	Write 8051 through Param0, wait for 10s and power on again to clear
3333	Communication timeout	Bus communication timeout	Replace the host
3134	X axis encoder battery error	The encoder has a battery dropout marker bit	Make sure the battery is well connected, set Param13 as 0 to clear
3235	Y axis encoder battery error	The encoder has a battery dropout marker bit	Make sure the battery is well connected, set Param13 as 0 to clear
3334	Z axis encoder battery error	The encoder has a battery dropout marker bit	Make sure the battery is well connected, set Param13 as 0 to clear
3136	Low battery voltage for X axis encoder	The encoder has a battery voltage low marker bit	Encoder voltage is too low
3237	Low battery voltage for Y axis encoder	The encoder has a battery voltage low marker bit	Encoder voltage is too low
3336	Low battery voltage for Z axis encoder	The encoder has a battery voltage low marker bit	Encoder voltage is too low
3138	X axis motor code is not consistent with the set value	The motor code read from the encoder is inconsistent with the set value	<ol style="list-style-type: none"> 1.Check whether Param2 is the correct motor code. If it is correct, it can be eliminated by restarting 2.If it is incorrect, set Param4 as 1, and then manually set Param2 as the correct motor code
3239	Y axis motor code is not consistent with the set value	The motor code read from the encoder is inconsistent with the setting	<ol style="list-style-type: none"> 1.Check whether Param2 is the correct motor code. If it is correct, it can be eliminated by restarting 2.If it is incorrect, set Param4 as 1, and then manually set Param2 as the correct motor code

3338	Z axis motor code is not consistent with the set value	The motor code read from the encoder is inconsistent with the set value	1.Check whether Param2 is the correct motor code. If it is correct, it can be eliminated by restarting 2.If it is incorrect, set Param4 as 1, and then manually set Param2 as the correct motor code
3140	X axis illegal motor code	System does not support this code	Set Param4 as 1 and manually set Param2 as correct motor code
3241	Y axis illegal motor code	System does not support this code	Set Param4 as 1 and manually set Param2 as correct motor code
3340	Z axis illegal motor code	System does not support this code	Set Param4 as 1 and manually set Param2 as correct motor code
3142	Position of X axis encoder does not refresh	No change in encoder value	Motor encoder abnormal
3243	Position of Y axis encoder does not refresh	No change in encoder value	Motor encoder abnormal
3342	Position of Z axis encoder does not refresh	No change in encoder value	Motor encoder abnormal
3144	X encoder multi-turn value alarm		Power off, remove the battery to reset the encoder/Param13 set as 0
3245	Y encoder multi-turn value alarm		Power off, remove the battery to reset the encoder/Param13 set as 0
3344	Z encoder multi-turn value alarm		Power off, remove the battery to reset the encoder/Param13 set as 0
3146	X motor power section mismatch	Param 1(motor power section) does not match with Param 2(motor code)	Check Param2 to confirm whether the motor code matches the power of Param1
3247	Y motor power section mismatch	Param 1(motor power section) does not match with Param 2(motor code)	Check Param2 to confirm whether the motor code matches the power of Param1
3346	Z motor power section mismatch	Param 1(motor power section) does not match with Param 2(motor code)	Check Param2 to confirm whether the motor code matches the power of Param1

3148	X axis parameter setting error	Parameter setting is not reasonable	Check if the parameters are in the rang:5(1, 6000), 6(1, 300),7(1-300), 11(10, 5000),15(10,100), 21(1, 1000), 22(0,300), 23(1, 20), 31(20000), 32(2000/20000),69(4096), 71(0), 72(0), 73(0)
3249	Y axis parameter setting error	Parameter setting is not reasonable	Check if the parameters are in the rang:5(1, 6000), 6(1, 300),7(1-300), 11(10, 5000),15(10,100), 21(1, 1000), 22(0,300), 23(1, 20), 31(20000), 32(2000/20000),69(4096), 71(0), 72(0), 73(0)
3348	Z axis parameter setting error	Parameter setting is not reasonable	Check if the parameters are in the rang:5(1, 6000), 6(1, 300),7(1-300), 11(10, 5000),15(10,100), 21(1, 1000), 22(0,300), 23(1, 20), 31(20000), 32(2000/20000),69(4096), 71(0), 72(0), 73(0)

Appendix Modbus Function Address and Parameter Definitions

Device station number: In Modbus request, it is used to distinguish multiple robotic devices (Default is 1). Baud rate, data bit, stop bit and check code are connection settings, please set your computer the same as the robot settings to keep the communication connection (Default: Baud rate: 115200; Data bits: 8; Stop bits: 1; Checksum: No checksum).

1-999 for readable address ,1000 for write address: product clear, most capital address is 2000.

Note: The data requesting “feedback of each axis” is different from other data in that it is byte-ordered to the small end and word-ordered to the end.

Description: The data of address number 4 is enabled when the data of address 3 is full, so the data of address 4 is always zero when address 3 not exceed 65535.

Address number	Data specification	Converting unit or data meaning
1	Equipment status	32 to stop ,96 to auto ,128 to manual
2	Production cycle time	Data *0.1, in s. units
3	Production output	The upper limit is 65535, after breaking the upper limit, count again and enter 1 next address, unit:1.
4	Production output	Data 65535, unit: one.
5	Operating parameter tolerance	Data *0.01, in mm. units
6	Operating parameter drawing distance	Data *0.1, in mm. units
7	Operating parameter X1 acceleration time	Data *0.01, in s. units
8	Operating parameter X1 deceleration time	Data *0.01, in s. units
9	Operating parameter X1 external acceleration/deceleration time	Data *0.01, in s. units
10	Operating parameter X1 manual acceleration/deceleration time	Data *0.01, in s. units
11	Operating parameters Y1 acceleration time	Data *0.01, in s. units
12	Operating parameters Y1 deceleration time	Data *0.01, in s. units
13	Operating parameter Y1 external acceleration/deceleration time	Data *0.01, in s. units
14	Operating parameter Y1 manual acceleration/deceleration time	Data *0.01, in s. units
15	Operating parameter Z acceleration time	Data *0.01, in s. units
16	Operating parameter Z deceleration time	Data *0.01, in s. units
17	Operating parameter Z manual acceleration/deceleration time	Data *0.01, in s. units
18	Operating parameter X1 maximum speed	Unit:%.

19	Operating parameter Y1 maximum speed	Unit:%.
20	Operating parameter Z maximum speed	Unit:%.
21	Operating parameter X2 acceleration time	Data *0.01, in s. units
22	Operating parameter X2 deceleration time	Data *0.01, in s. units
23	Operating parameter X2 external acceleration/deceleration time	Data *0.01, in s. units
24	Operating parameter X2 manual acceleration/deceleration time	Data *0.01, in s. units
25	Operating parameter Y2 acceleration time	Data *0.01, in s. units
26	Operating parameter Y2 deceleration time	Data *0.01, in s. units
27	Operating parameter Y2 external acceleration/deceleration time	Data *0.01, in s. units
28	Operating parameter Y2 manual acceleration/deceleration time	Data *0.01, in s. units
29	Operating parameter A acceleration time	Data *0.01, in s. units
30	Operating parameter A deceleration time	Data *0.01, in s. units
31	Operating parameter A external acceleration/deceleration time	Data *0.01, in s. units
32	Operating parameter A manual acceleration and deceleration time	Data *0.01, in s. units
33	Operating parameter B acceleration time	Data *0.01, in s. units
34	Operating parameter B deceleration time	Data *0.01, in s. units
35	Operating parameter B external acceleration/deceleration time	Data *0.01, in s. units
36	Operating parameter B manual acceleration and deceleration time	Data *0.01, in s. units
37	Operating parameter C acceleration time	Data *0.01, in s. units
38	Operating parameter C deceleration time	Data *0.01, in s. units
39	Operating parameter C external acceleration/deceleration time	Data *0.01, in s. units
40	Operating parameter C manual acceleration and deceleration time	Data *0.01, in s. units
41	Operating parameter X2 maximum speed	Unit:%.
42	Operating parameter Y2 maximum speed	Unit:%.
43	Operating parameter A maximum speed	Unit:%.
44	Operating parameter B maximum speed	Unit:%.
45	Operating parameter C maximum speed	Unit:%.
46	Machine parameter X1 axis maximum movement	Data *0.1, in mm. units
47	Machine parameter X1 axis origin offset	Data *0.1, in mm. units
48	Machine parameter X1 minimum movement in axial mode	Data *0.1, in mm. units
49	Machine parameter X1 maximum movement within shaft	Data *0.1, in mm. units
50	Machine parameter X1 axis rotation distance	Data *0.01, in mm. units

51	Monitor page X1 axis feedback	The upper limit is 65535, count again after breaking the upper limit and enter 1 next address, unit: pulse number.
52	Monitor page X1 axis feedback	Data 65535, unit: pulse number.
53	Machine parameter Y1 axis maximum movement	Data *0.1, in mm. units
54	Machine parameter Y1 axis origin offset	Data *0.1, in mm. units
55	Machine Parameter Y1 Shaft Maximum Standby Position	Data *0.1, in mm. units
56	machine parameter Y1 axis off origin position	Data *0.1, in mm. units
57	Machine parameter Y1 axis rotation distance	Data *0.01, in mm. units
58	Monitor page Y1 axis feedback	The upper limit is 65535, count again after breaking the upper limit and enter 1 next address, unit: pulse number.
59	Monitor page Y1 axis feedback	Data 65535, unit: pulse number.
60	Machine parameter Z axis maximum movement	Data *0.1, in mm. units
61	Machine parameter Z axis origin offset	Data *0.1, in mm. units
62	Machine parameter Z shaft safety	Data *0.1, in mm. units
63	External safety of machine parameter Z shaft	Data *0.1, in mm. units
64	Machine parameter Z axis rotation distance	Data *0.01, in mm. units
65	Monitor page Z axis feedback	The upper limit is 65535, count again after breaking the upper limit and enter 1 next address, unit: pulse number
66	Monitor page Z axis feedback	Data 65535, unit: pulse number.
67	Machine parameter X2 axis maximum movement	Data *0.1, in mm. units
68	Machine parameter X2 axis origin offset	Data *0.1, in mm. units
69	Machine parameter X2 minimum position within the module	Data *0.1, in mm. units
70	Machine parameter X2 maximum position in the module	Data *0.1, in mm. units
71	Machine parameter X2 per rotation distance	Data *0.01, in mm. units
72	Feedback X2 monitoring pages	The upper limit is 65535, count again after breaking the upper limit and enter 1 next address, unit: pulse number.
73	Feedback X2 monitoring pages	Data 65535, unit: pulse number.
74	Machine parameter Y2 axis maximum movement	Data *0.1, in mm. units

75	Machine parameter Y2 axis origin offset	Data *0.1, in mm. units
76	Machine parameter Y2 - axis maximum standby position	Data *0.1, in mm. units
77	Machine parameter Y2 - axis leaves the origin position	Data *0.1, in mm. units
78	Machine parameter Y2 - axis per rotation distance	Data *0.01, in mm. units
79	Monitoring the page with the Y2 - axis feedback	The upper limit is 65535, count again after breaking the upper limit and enter 1 next address, unit: pulse number.
80	Monitoring the page with the Y2 - axis feedback	Data 65535, unit: pulse number.
81	Machine parameter A - axis maximum rotation	Data *0.1, in mm. units
82	Machine parameter A - axis origin offset	Data *0.1, in mm. units
83	Machine parameter A - axis rampant safety range (less than)	Data *0.1, in mm. units
84	Machine parameter A - axis overrun range (greater than)	Data *0.1, in mm. units
85	Machine parameter A - axis motor per lap	Data *0.01, in mm. units
86	Machine parameter A - axis feedback	The upper limit is 65535, count again after breaking the upper limit and enter 1 next address, unit: pulse number.
87	Machine parameter A - axis feedback	Data 65535, unit: pulse number.
88	Machine parameter B - axis maximum rotation	Data *0.1, in mm. units
89	Machine parameter B - axis origin offset	Data *0.1, in mm. units
90	Machine parameter B - axis rampant safety range (less than)	Data *0.1, in mm. units
91	Machine parameter B - axis overrun range (greater than)	Data *0.1, in mm. units
92	Machine parameter B - axis motor per lap	Data *0.01, in mm. units
93	Machine parameter B - axis feedback	The upper limit is 65535, count again after breaking the upper limit and enter 1 next address, unit: pulse number.
94	Machine parameter B - axis feedback	Data 65535, unit: pulse number.
95	Machine parameter C - axis maximum rotation	Data *0.1, in mm. units
96	Machine parameter C - axis origin offset	Data *0.1, in mm. units
97	Machine parameter C - axis rampant safety range (less than)	Data *0.1, in mm. units
98	Machine parameter C - axis overrun range (greater than)	Data *0.1, in mm. units
99	Machine parameter C - axis motor per lap	Data *0.01, in mm. units

100	Machine parameter C - axis feedback	The upper limit is 65535, count again after breaking the upper limit and enter 1 next address, unit: pulse number.
101	Machine parameter C - axis feedback	Data 65535, unit: pulse number.
102	Machine parameter time is vertical 1	Data *0.1, in s. units
103	Machine parameter time level 1	Data *0.1, in s. units
104	Machine parameter time is vertical 2	Data *0.1, in s. units
105	Machine parameter time level 2	Data *0.1, in s. units
106	Machine parameter time auxiliary arm drop	Data *0.1, in s. units
107	Machine parameter time for secondary arm rise	Data *0.1, in s. units
108	Machine Parameters Time Side Arm Forward	Data *0.1, in s. units
109	Machine Parameters Time Side Arm Back	Data *0.1, in s. units
110	Machine parameter time main arm forward	Data *0.1, in s. units
111	Machine parameter time main arm back	Data *0.1, in s. units
112	Machine Parameters Time Main Arm Rise	Data *0.1, in s. units
113	Machine parameter time main arm descent	Data *0.1, in s. units
114	Machine parameter time transversal	Data *0.1, in s. units
115	Machine Parameter Time Transverse	Data *0.1, in s. units
116	Alarm number	The data is numbered and has no unit.
117	Version Number	
...	
1000	Products cleared	
...	
2000	



Core supplier in the field of industrial control

Shenzhen Huacheng Industrial Control Co.,LTD



☎ 0755-26417678/27470348

Fax: (86) 075526417678

Official Website: www.hc-system.com

Address: 8/F,Zhengqilong Building No.108,Gushu 1st Road,Baoan,Shenzhen